



1000 MIGLIA 2026
Brescia, from 7 to 13 June 2026

SPECIAL RACE REGULATIONS
(S.R.R.)

This draft of the Special Race Regulations, together with its attached, was sent to ACI - Sport for approval the 3 November 2025 and published on the organizer website on the 4 November 2025.

ORGANISATION: **1000 Miglia S.r.l.**

PREVIOUS MILLE MIGLIA WINNERS

Year	Drivers	Car	Cl.	Cm ³	CV	Brescia-Rome	Total time	Avg.
1927	Minoja – Morandi	OM 665 SPORT	6	1.999	80	7:25'00"	21:04'48"	77,238
1928	Campari – Ramponi	ALFA ROMEO 6C 1500 SS	6	1.487	84	6:46'00"	19:14'05"	84,128
1929	Campari – Ramponi	ALFA ROMEO 6C 1750 SS	6	1.752	90	6:26'00"	18:04'23"	89,688
1930	Nuvolari – Guidotti	ALFA ROMEO 6C 1750 GS	6	1.752	102	6:02'00"	16:18'59"	100,45
1931	Caracciola - Sebastian	MERCEDES -BENZ SSKL	6	7.065	280	6:03'25"	16:10'10"	101,15
1932	Borzacchini - Bignami	ALFA ROMEO 8C 2300 SPIDER	8	2.336	150	5:40'00"	14:55'19"	109,88
1933	Nuvolari - Compagnoni	ALFA ROMEO 8C 2300 SPIDER	8	2.336	160	5:33'26"	15:11'50"	108,58
1934	Varzi – Bignami	ALFA ROMEO 8C 2600 MONZA	8	2.556	180	5:51'34"	14:08'05"	114,31
1935	Pintacuda - Della Stufa	ALFA ROMEO TIPO B "P3"	8	2.905	240	5:28'09"	14:04'47"	114,75
1936	Brivio – Ongaro	ALFA ROMEO 8C 2900 A	8	2.905	230	5:25'50"	13:07'51"	121,62
1937	Pintacuda - Mambelli	ALFA ROMEO 8C 2900 A	8	2.905	255	5:27'55"	14:17'32"	114,75
1938	Biondetti - Stefani	ALFA ROMEO 8C 2900 B MM	8	2.905	250	5:34'56"	11:58'29"	135,39
1940	von Hanstein - Baumer	BMW 328 BERLINETTA	6	1.971	120		8:54:46"	166,72
1947	Romano - Biondetti	ALFA ROMEO 8C 2900 B BERLINETTA	8	2.905	180	6:35'00"	16:16'39"	112,24
1948	Biondetti - Navona	FERRARI 166 S COUPE'	12	1.995	120	6:02'00"	15:05'44"	121,23
1949	Biondetti - Salani	FERRARI 166 MM SPIDER	12	1.995	140	5:13'43"	12:07'05"	131,46
1950	Marzotto G. - Crosara	FERRARI 195 S BERLINETTA	12	2.341	170	6:55'45"	13:39'20"	123,21
1951	Villoresi - Cassani	FERRARI 340 AMERICA BERLINETTA	12	4.101	230	7:18'55"	12:50'18"	121,82
1952	Bracco – Rolfo	FERRARI 250 S BERLINETTA	12	2.953	230	6:57'53"	12:09'45"	128,59
1953	Marzotto - Crosara	FERRARI 340 MM SPIDER	12	4.101	280	6:19'20"	10:37'19"	142,35
1954	Ascari A.	LANCIA D24 SPIDER	6	3.284	245	6:02'00"	11:26'10"	139,65
1955	Moss - Jenkinson	MERCEDES-BENZ 300 SLR	8	2.979	310	5:03'02"	10:07'48"	157,65
1956	Castellotti	FERRARI 290 MM	12	3.490	320	5:41'30"	11:37'10"	137,44
1957	Taruffi	FERRARI 315 S	12	3.783	360	5:08'38"	10:27'47"	152,63
1958	Taramazzo	FERRARI 250 GT	12	2.953	250		0:55'02"	
1959	Abate - Balzarini	FERRARI 250 GT	12	2.953	260		2:06'16"	
1961	Andersson - Lohmander	FERRARI 250 GT	12	2.953	280		3:32'53"	

INDEX

Articles:

1.	DEFINITIONS.....	4
2.	ORGANISATION	6
3.	PROGRAMME	7
4.	RACE.....	10
5.	ROUTE	10
6.	COMPETITORS, DRIVERS AND CARS ALLOWED	10
7.	RACE NUMBER AND STARTING ORDER	14
8.	ENTRIES.....	14
9.	GENERAL OBLIGATIONS.....	22
10.	RUNNING OF THE RACE	25
11.	MAXIMUM LATENESS.....	27
12.	PENALTIES AND DISCIPLINARY MEASURES.....	27
13.	CLASSIFICATION-PROTESTS AND APPEALS.....	28
14.	PRIZES	29
15.	GENERAL RULES	29
16.	INSURANCE	30
17.	APPENDIXES	
	01. Fac-simile of the Medical Certificate for non-competitive sports activity	33
	02. Positioning of the Race numbers on the cars.....	34
	03. Itinerary, Times and Distance Table	35
	(The TDT will be distributed together with the Road book)	
	04. Maps.....	36
	(The maps may be subject to modification and will be distributed together with the Road book)	
	05. Signage of Controls.....	37
	06. Table of Coefficients.....	39
	07. Table of scores for Time Trials (PC/TT)	60
	08. Table of scores for Average Trials (PM/AT).....	62

1. DEFINITIONS

Unless otherwise defined in the body of these SRR or in the General Terms and Conditions, the following terms shall have the following meanings:

- 1.1 ASN:** means the National Sporting Association/Federation recognised by the International Automobile Federation in each country as the only sporting power qualified to apply the code of ethics adopted by the same and to regulate motor sports in all the territories under its jurisdiction.
- 1.2 Admitted Drivers:** means the Crew members admitted and verified to drive the car entered by the Competitor.
- 1.3 Chairman of the Stewards:** these are the officials indicated in Art. 2.4 of these SRR.
- 1.4 Clerk of the Course:** means the official as per art. 2.4 of these SRR.
- 1.5 Co-Driver:** means the Crew member assisting the driver.
- 1.6 Coefficient Tables (TDC):** means the correction coefficients of the cars that can be entered in the Event applied to compensate and equalise the technical and performance characteristics of the same, as per the tables attached to the SRR.
- 1.7 Competitor(s):** means the natural or legal person holding a Sports Licence suitable to enter a car and its drivers for the Event.
- 1.8 CO/TC:** means the time control(s) that regulates/regulate the timing of the race.
- 1.9 CPI:** means the personal identification mark suitable to uniquely and incontrovertibly identify a Driver.
- 1.10 Crew:** means the crew appointed by the Competitor for each entered and/or admitted car composed of a maximum of 2 (two) Drivers.
- 1.11 CSN:** means the national sports code adopted by ACI Sport.
- 1.12 CT/PC:** means the passage controls.
- 1.13 Driver:** means the natural person who takes part in the race with the role of driver and/or co-driver of an entered car. The driver(s) is/are indicated by the Competitor and must be in possession of the requirements of art. 6 of these SRR.
- 1.14 Driver:** means the Crew member driving the car.
- 1.15 FIA HERITAGE CERTIFICATE:** means the certificate issued by the Federation Internationale de l'Automobile.
- 1.16 FICHE ACI SPORT:** means the national technical document issued by Automobile Club Italia.
- 1.17 FIVA INTERNATIONAL IDENTITY CARD:** means the international document issued by the Fédération Internationale des Véhicules Anciens.
- 1.18 General Terms and Conditions:** these are the general terms and conditions containing the terms and conditions of entry of competitors and forming an integral part of these SRR for anything not expressly derogated from or supplemented by the same.
- 1.19 GPS TRACKER:** means the electronic equipment made available by the Organiser and installed on the vehicle.
- 1.20 Guest Car:** means a car entered with a specific application for entry and admitted to a special classification.
- 1.21 HTP/FIA:** means the *Historical Technical Passport* of the car issued by the *Federation Internationale de l'Automobile*.
- 1.22 Leg:** means the leg of the race scheduled in the Programme.

- 1.23 OM brand:** means the brand of the car(s) produced by Officine Meccaniche (formerly Miani e Silvestri & C - A. Grondona Comi & C. of Milan) founded in 1899 and closed down in 1975.
- 1.24 Operating and Selection Committee:** means the committee composed of the members referred to in art. 2.3 of these SRR, appointed by the Organiser, with the task of proposing the admission to and/or exclusion of the cars from the Event.
- 1.25 Organiser:** means 1000 Miglia S.r.l. with registered office in Brescia, Via Enzo Ferrari 4/6, holder of ACI Sport licence n. 356540, Tax Code and VAT no. 03440020984, registered with the Brescia Companies' Register under n. 534270.
- 1.26 Paddock:** means the area set up by the Organiser to carry out the administrative checks and scrutineering for the race.
- 1.27 TT:** means the time trials.
- 1.28 AT:** means the average trials.
- 1.29 Programme:** means the race programme referred to in art. 3 of these SRR.
- 1.30 Race:** means the car race called "1000 MIGLIA 2026".
- 1.31 Race Officials:** means the race officials referred to in Article 2.4 of these SRR.
- 1.32 Registered Trademarks:** means the following trademarks: "MILLE MIGLIA", "1000 Miglia" both verbal and figurative.
- 1.33 RNS:** means the National Sporting Regulations adopted by ACI Sport and its sector regulations, as applicable.
- 1.34 Road Book:** means the document prepared by the Organiser indicating the route of the Race.
- 1.35 Special List:** means the list of no more than 30 (thirty) cars, selected by the Organiser, which are of high historical and/or sporting interest and which were not entered into the 1000 Miglia 1927-1957 or whose year of construction is prior to 1927.
- 1.36 Sponsor:** means sponsors who have a sponsorship contract with the Organiser.
- 1.37 Sponsor Team:** means the team of cars indicated by the sponsor in its team in accordance with the sponsorship contract.
- 1.38 SRR:** means these Special Race Regulations.
- 1.39 TDT:** means the itinerary, times and distance table attached to the SRR, the final version of which is included in the Road Book or in the Information Bulletins.
- 1.40 Technical Support Convoy:** this refers to the pathfinder, "*pace car*" and "*technical car*" as well as other vehicles defined and appointed by the Organiser and their crews.
- 1.41 Time Card:** means the document showing the transit times recorded at the CO/TCs.
- 1.42 Website:** means the website <https://1000miglia.it/>
- 1.43 Waiting List:** this is the waiting list prepared by the Organiser for the competitors who have applied for entry but have not been accepted by the date of publication of the list of Competitors and cars admitted.

All the times stated in these SR are understood as referring to the Time Zone in use in Italy, namely "*Greenwich Mean Time + 1 hour*" conventionally UTC (GPS) signal | Italy: GMT+1

Value Added Tax (VAT) will be applied on all amounts stated in these SR at a rate of 22% (updated to 13.10.2025). Any variation on this percentage will be notified in the Bulletin and will be enforced in compliance with the laws issued by Italy.

TO ALL LEGAL EFFECTS, THE ITALIAN VERSION OF THESE SRR WILL BE BINDING. THE ENGLISH TRANSLATION OF THE SAME IS UNDERSTOOD AS BEING SOLELY FOR INFORMATION PURPOSES.

2. ORGANISATION

2.1. This event will be run in compliance with the RNS and with other provisions of the ACI Sport, which are understood to regulate whatever is not indicated in the following articles.

2.2. The Organiser states that the race will have all the necessary administrative authorisations and the required insurance coverage.

2.3. The Operational and Participant Selection Committee is composed of:

Chairman: Mr.
 Vice Chairman: Mr.
 Secretary: Mr.
 Members: Mr.
 Members: Mr.
 Members: Mr.
 Head office: 1000 MIGLIA s.r.l. - Via Enzo Ferrari, 4/6 - 25134 - Brescia

2.4. OFFICIALS

Sports commissioners:

- Chairman of Stewards Mr. t.b.a. (ASN Sport Delegate) licence
- Steward Mr. t.b.a. licence
- Steward Mr. t.b.a. licence
- Stewards' secretary Mr. t.b.a. licence

Clerk of the course: Mr. Lucio DE MORI licence 20623
 Deputy Clerk of the course: Mr. t.b.a. licence

Event Secretary: Mr. t.b.a. licence

Safety Manager: Mr. t.b.a. licence

Chief Medical Officer: Dr. t.b.a. licence

Competitor Relations Officers: The list will be published by a Bulletin
 Judges of fact: The list will be published by a Bulletin
 Sporting Operations Inspectors: The list will be published by a Bulletin

Scrutineers: Mr. t.b.a. (ACI Sport delegate) licence

Scrutineers and Scrutineer Assistant: The list of will be published by a Bulletin

Marshals: of the Automobile Club Brescia and of the Automobile Clubs of other affected Provinces

Time keeping Service: Federazione Italiana Cronometristi (F.I.C.R.)
 Head of Timing Service: Mr. t.b.a. licence

Results: Mr. t.b.a. licence

Press Officer: Mr. t.b.a. licence

3. PROGRAMME

3.1 Programme before the race week

Tuesday 4 November 2025

Date of publication of SR

Website

Opening date for entries

Race Secretary

Thursday 15 January 2026 at 04:00 pm

Closing Date for entries

Race Secretary

Thursday 12 February 2026 at 04:00 pm

Closing Date for entries reserved for cars indicated by Sponsors, according to sponsorship contracts

Race Secretary

Thursday 26 February 2026 at 04:00 pm

Deadline for communication of crews belonging to a "Sponsor Team"

Race Secretary

by Friday 3 April 2026

Communication to entrants of their acceptance, acceptance of the cars And relative coefficients assigned

Race Secretary

Publication of list of Competitors and cars accepted

Website

Thursday 30 April 2026 at 04:00 pm

Finale date to enter Cars with Platinum fee

Race Secretary

Friday 15 May 2026 at 04:00 pm

Final date for communicating the free of charge variation of the data of the drivers not indicated during the entry phase

Race Secretary

Deadline for the free of charge request of change an entered car

Race Secretary

Deadline for sending of graphics for a Sponsor Team sticker

Race Secretary

Deadline for sending the documents required to carry out pre-checks

Race Secretary

by Wednesday 3 June 2026

Deadline for the refund of deposit payment from competitors who have not been accepted and who were not on the waiting list

Race Secretary

Closing Date for the waiting list

Race Secretary

Wednesday 3 June 2026

Briefing of the Organisers and the Clerk of the course

Sent to each entrant

Thursday 4 June 2026

Publication of individual verification schedules

Website – ONB

By Saturday 6 June 2026 at 12:00 am

Publication of individual starting order and times of the 5 Legs

Website – ONB

3.2 Programme for the race Week

The times shown on the programme for all activities which precede the start of the race will be confirmed by a board showing the official time of the event, placed in the inspection area by the Timekeeping service.

All crew members who have not reported within the times stated in these SRR will be understood as having withdrawn and will not be admitted to the race; no exceptions will be made.

Sunday 7 June 2026

10:00 - 19:00 Administrative checks, scrutineering and Road Book distribution (according to individual convocation times communicated)

Brescia, Paddock Expo

Monday 8 June 2026

10:00 - 19:00 Administrative checks, scrutineering and Road Book distribution (according to individual times communicated)

Brescia, Paddock Expo

10:00 - 20:00 Sealing and Presentation ceremony of the cars (according to individual times communicated at the Scrutineering)

Brescia, Piazza Vittoria

Up until 20:00	Exhibition of the sealed cars	City centre square
Tuesday 9 June 2026		
07:30 - 08:30	Administrative checks, scrutineering and Road Book distribution (according to individual convocation times communicated)	Brescia, Paddock Expo
07:30 - 08:30	Entry of Crews on the "Waiting List"	Brescia, Paddock Expo
09:00 - 10:00	Administrative checks and scrutineering, for Crews on the "Waiting List"	Brescia, Paddock Expo
08:30 - 10:00	Sealing of the scrutineered cars (according to individual times communicated at the Scrutineering)	Brescia, Piazza Vittoria
Up until 10:00	Exhibition of the sealed cars	Brescia, city centre square
10:00	Publication of list of competitors and accepted cars	Website – ONB
from 10:00	Lining up for start of Leg 1	Brescia, Viale Venezia
10:30	Departure of first car – Leg 1	Brescia, Viale Venezia
21:00	Arrival of first car – Leg 1	Padova, Prato della Valle
Wednesday 10 June 2026		
06:30	Publication of partial classification of Leg 1	Website – ONB
from 06:30	Lining up for start of Leg 2 (minimum 30' before the individual starting time)	Padova, Prato della Valle
07:00	Departure of first car – Leg 2	Padova, Prato della Valle
20:00	Arrival of first car – Leg 2	Montecatini Terme, TBA
Thursday 11 June 2026		
06:30	Publication of partial classification of Leg 2	Website – ONB
from 06:30	Lining up for start of Leg 3 (minimum 30' before the individual starting time)	Montecatini Terme, TBA
07:00	Departure of first car - Leg 3	Montecatini Terme, TBA
20:00	Arrival of first car - Leg 3	Roma, Villa Borghese
Friday 12 June 2026		
05:30	Publication of partial classification of Leg 3	Website – ONB
from 05:30	Lining up for start of Leg 4 (minimum 30' before the individual starting time)	Roma, Parco de Medici
06:00	Departure of first car - Leg 4	Roma, Parco de Medici
18:30	Arrival of first car - Leg 4	Rimini, Cavour square
Saturday 13 June 2026		
05:30	Publication of partial classification of Leg 4	Website – ONB
from 05:30	Lining up for start of Leg 5 (minimum 30' before the individual start time)	Rimini, Clementini Parking
06:00	Departure of first car - Leg 5	Rimini, Clementini Parking
16:30	Arrival of first car - Leg 5 and passage on the ramp	Brescia, Continente Parking
from 16:45	Mandatory Passage on the ramp	Brescia, Viale Venezia
18:00	Publication of final classification	Website – ONB
18:00	Prize giving ceremony	Brescia, TBA

3.3.1 Race Headquarters, Race Secretary and Paddock

Brixia Expo - Fiera di Brescia, Via Caprera 5 – 25125 – Brescia

3.3.2 Leg Secretaries

PADOVA – TBD
from 20:00 of Tuesday 9 to 01:00 of Wednesday 10 June 2026

MONTECATINI TERME (PISTOIA) – TBD
from 18:00 to 00:00 of Wednesday 10 June 2026

ROMA – TBD
from 18:00 to 00:00 of Thursday 11 June 2026

RIMINI – TBD
from 18:00 to 00:00 of Friday 12 June 2026

3.3.3 Official Notice Board – Official Notice Board

Brescia (race Headquarters), Leg Secretaries, Website and App Sportity

- **Website - DNB** www.1000Miglia.it
 - **App Sportity** password: **1000MIGLIA2026**
-

3.4 Synchronization of the Organisation's time-keeping systems: **UTC (GPS) signal** | Italia: GMT+1

4. RACE

The Organiser 1000 MIGLIA S.r.l. announce and organise, as from Sunday 7 June to Saturday 13 June 2026 a Classic Regularity Race for Historical Cars, Grande Evento, to be known as:

1000 MIGLIA 2026

5. ROUTE

The race route will have an overall length of Km 2.091,00 and will be described in the Itinerary Table (TDT) attached to these SRR, and of which it is an integral part, and in the Road Book. The TDT will also show the methods of carrying out the timed Legs for classification.

There will be 23 Time Controls (CO/TC), 144 Time Trials (PC/TT), 8 Average Trials (PM/AT) with a total of ___TBD___ readings and 25 Passage Controls (CT/PC).

The start and finish of the race are scheduled at the places and times indicated in the race Programme.

The race will take place on roads open to traffic, barring any limitations set by the competent Administration Authorities, with average speeds not exceeding 50 Km/h.

Any route changes due to road works, or temporary obstructions, will be notified with Bulletins directly on site, if possible, by the Police or by persons appointed by the organisation.

6. COMPETITORS, DRIVERS AND CARS ALLOWED

6.1 COMPETITORS AND DRIVERS ALLOWED

6.1.1 Competitors, and crew members must hold a valid ACI Sport Competitor/Driver's Licence or a valid regularity licence (for Italian competitors/Drivers) or a valid Co-driver or Competitor/Driver's licence, issued by their ASN (for foreign competitors/drivers of International or National - with authorisation to compete in the event - level) valid in Italy.

6.1.2 At least one of the two crew members must be in possession of a valid driving licence during all the legs of the race. Crew members without an Italian driving licence, or in any case valid in Italy, must also present, if necessary, an international driving licence, valid in Italy.

6.1.3 For each vehicle, a competitor may enter a crew, comprising of maximum 2 persons, who must be on board the vehicle during all phases of the race.

6.1.4 A competitor who is a physical entity, entering a vehicle for the race must always be on board the vehicle throughout the race. In the case of a Competitor being a legal person, he/she may enter more than one car and appoint a Crew for each one, but it is expressly forbidden to exchange Crews between the entered cars.

6.1.5 During all the phases of the race the vehicle may be driven only by crew members who have been verified as drivers and accepted with that specific vehicle.

6.1.6 Crew members below the age of 14 (i.e. those who have not yet turned 14 at the date of the end of the checks) and older than 85 years of age (i.e. those who will not have reached 86 years of age on 13.06.2026).

6.1.7 Passengers will not be allowed, that is, crew-members who have not been verified and who are not in possession of the requirements of Articles 6.1.1, 6.1.2 and 6.1.6 of these SRR.

6.1.8 The substitution of a competitor after the close of entries, is not permitted. Crew members may be replaced:

- a. with the authorisation of the Organiser, up to the start of administrative checks;
- b. with the authorisation of the Stewards, from the start of checks until publication of list of admitted competitors and crews and of the accepted race cars.

The substitution of two members of the crew is subject to the approval of the Organiser, in accordance with the ASN of the organiser.

6.1.9 Until 4:00 p.m. on Friday 15th May 2026, the first replacement of both crew members or the inclusion of names not previously communicated are free of charge. From 16:01 p.m. on Friday 15th May 2026 each replacement or insertion of a crew member will have to be paid for an amount of € 366,00 (equal to € 300,00 + VAT), as administration fees.

If payment is not made, the request for replacement will not be considered valid.

It will not be possible to replace both crew members if the car has already been replaced. This provision does not apply to entries for "Sponsor Team" cars/crew members.

- 6.1.10** In case of replacement of a crew member registered with Young or UNUCI quota, the new member must comply with all the requirements that allow him of these types of registrations. Otherwise, the competitor will be required to pay the difference in fee to transform the initial registration into one of the fees provided for in articles 8.10.1 or 8.10.2 or 8.10.3. The conversion of the Young or UNUCI quota into one of the quotas provided for in the articles 8.10.1 or 8.10.2 or 8.10.3 will not entitle participants to receive any gifts distributed directly by the Sponsors. Failure to convert the registration quota will result in the vehicle being removed from the event under the conditions set out in art. 8.14.

6.2 DOCUMENTATION REQUIRED IN ORDER TO OBTAIN A SPORTS LICENCE

The maximum age for obtaining the regularity licence, whether daily for foreigners or annual for Italians, is 85 years for both sexes. Below is the list of the documentation necessary for obtaining the prescribed licence:

a) Drivers of Italian nationality UNDER 85 at the date of the closure of the race

In order to issue/renew the licence, the following documents are required:

- medical certificate for non-competitive sports activities (Facsimile in Appendix 1 to these SR) obtained in Italy as per current regulations;
- driving licence (only for drivers);
- ACI membership card (for those not in good standing with the association, it will be possible to renew/issue this on-site by communicating the data of the car used every day, or the licence plate number of the historic car entered in the race, depending on the type of ACI Service required).

b) Co-drivers (not permitted to drive the car) of Italian nationality UNDER 85 at the date of the end of the race

In order to issue/renew the licence, the following documents are required:

- medical certificate for non-competitive sports activities (Facsimile in Appendix 1 to these SR) obtained in Italy as per current regulations;
- ACI membership card (for those not in good standing with the association, it will be possible to renew/issue this on-site by communicating the data of the car used every day, or the licence plate number of the historic car entered in the race, depending on the type of ACI Service required).

c) Drivers not of Italian nationality UNDER 85 at the date of the end of the race

In order to issue/renew the licence, the following documents are required:

- medical certificate for non-competitive sports activities (Facsimile in Appendix 1 to these SR) obtained in Italy as per current regulations; alternatively, a medical certificate of good health issued abroad, written in English, signed and stamped by a doctor.
- self-certification stating you do not hold other valid licences issued by other ASN and to not having incurred disciplinary sanctions;
- national and international driving licence.

d) Co-drivers (not permitted to drive the car) not of Italian nationality UNDER 85 at the date of the end of the race

In order to issue/renew the licence, the following documents are required:

- medical certificate for non-competitive sports activities (Facsimile in Appendix 2 to these SR) obtained in Italy as per current regulations; alternatively, a medical certificate of good health issued abroad, written in English, signed and stamped by a doctor.
- self-certification to not possessing other valid licences issued by other ASN and to not having incurred disciplinary sanctions.

6.3 SPONSOR

The Sponsors of 1000 Miglia 2026 who are entitled, by contract, will be able to:

- a) Enter cars until Thursday 12th February 2026 (Article 8.3.2 of these SR).
- b) convey the names of the crews free of charge by and not later than Friday 15th May 2026. After this date, the art. 6.1.8 and 6.1.9 of the present SR will be considered valid.
- c) designate, within the vehicles forming part of their quota, one or more cars named "Guest Car" (Article 6.4. of these SR).

6.4 SPONSOR TEAM

The cars indicated by the sponsors in their quota, as per the sponsorship contract, will form the "Sponsor Team" which will benefit from the following conditions:

- a) the use of an additional advertising space (adhesive) on the sides of the race car (Article 15.3 in these SR) for each car that is part of the sponsor team;
- b) the possibility of including one or more race cars registered for the event in a "Sponsor Team" (Article 7.3 in these SR) in the starting order.

6.5 GUEST CAR

Sponsors who are entitled by contract (Article 6.3 of these SR) have the possibility to designate one or more cars called "Guest Car" within the vehicles forming part of their quota.

Competitors who opt for Platinum entry (Article 8.10.4 of this SR) will use the "Guest Car" option for the vehicle registered by them without any possibility of waiver.

- 6.5.1 The competitor entering a "Guest Car" can enter more than one driver for the car, up to a maximum of 6 (six) drivers.
- 6.5.2 It is obligatory for the competitors and at least one of the crew members of a "Guest Car" to submit to the sports checks in Brescia according to the methods described in Article 9.1 below.
- 6.5.3 Also crew members who have completed the administrative checks at the Leg Secretariats (Padova, Montecatini Terme, Roma, Rimini) may drive the car after having passed the prescribed checks. Competitors being physical persons who enter a "Guest Car" must be on board the car.
- 6.5.4 Should entrants registered with the Guest Car formula choose to carry out scrutineering at the Leg Secretariats, they must communicate within 15 days from the start of the race for which drivers this solution is required and at the end of which leg. For each identified driver, all documents necessary to pass the Sporting Checks (licence, medical examination, driving licence, international licence if any) must be sent in advance to the organiser by e-mail through his account within the abovementioned deadline. Each leg secretariat will carry out the scrutineering from 21.00 to 22.00 on each single day of activity.
- 6.5.5 Physical person competitors registering a "Guest Car" must then physically be aboard the said car.
- 6.5.6 Should a "Guest Car" be registered by a Legal Entity Competitor, the drivers who are registered and checked will be free to alternate their positions on board the car.
- 6.5.7 Competitors and drivers participating at the race on board a "Guest Car" must comply fully with these SR.
- 6.5.8 Vehicles with Platinum entry or designated as part of Sponsorship contracts such as "Guest Car" will be classified exclusively in a dedicated ranking.

6.6 ACCEPTED CARS

- 6.6.1 Race cars classified in periods C, D, E and those models registered for the 1000 Miglia Speed race (1927 - 1957), will be accepted.

Accepted cars will be divided into the following 3 groupings:

- a) 1st Grouping race cars belonging to Period C (vehicles built from 1927 to 1930)
- b) 2nd Grouping race cars belonging to Period D (vehicles built from 1931 to 1946)
- c) 3rd Grouping race cars belonging to Period E (vehicles built from 1947 to 1957)

- 6.6.2 Cars built after 1957 will not be accepted.
- 6.6.3 Cars built before 1927, limited to those models which were registered in the 1000 Miglia speed race (1927 > 1957), may be accepted.
- 6.6.4 A maximum of 405 cars may be accepted, of which up to 30 belonging to the "Special List" (cf. art. 6.6.6 of these SR). In addition, a maximum of a further 25 cars may be accepted for cultural and/or category E.R. (Educational Reconstruction); of these, may be accepted up to a maximum of 10 cars with "Young" quota and up to a maximum of 8 cars with State Bodies quota.
- 6.6.5 The entered car will be evaluated based on the documents inserted during the entry phase. The Selection Committee has the authority to exclude from the race an accepted car should it become aware of documents or facts that lead to the exclusion of the vehicle.
- 6.6.6 **Race cars, selected by the Organiser, that are of great historical and/or sports interest, and**

that, in respect of periods indicated above, were not registered in the 1000 Miglia speed race (1927>1957), may be accepted in the "Special List". The Operations Committee will establish which cars to accept into the "Special List", with independent and final decisions.

- 6.6.7** To be entered into the Race, all the cars must have the 1000 Miglia Registro Certificate or the temporary entry number issued by the Registro itself upon completion of the entry procedure. In all cases, regardless of the person who submits the application to enter a car for the 1000 Miglia, the vehicle must be in good standing with the payment of the annual membership fee of the Registro 1000 Miglia, otherwise the system will not allow the car to be entered for the race. This obligation does not exist for cars admitted with a cultural and educational purpose.
- 6.6.8** In order to be accepted to the administrative and technical checks, entered cars must have obtained the Provisional or Definitive certificate from the Registro 1000 Miglia. This requirement does not apply to cars entered for cultural purposes or belonging to the E.R. (Educational Reconstruction) category. Where applicable, the metal radiator grille plate, issued with registration in the Registro 1000 Miglia, must be attached on entered cars.
- 6.6.9** In addition to this document, the valid FIVA International Identity Card and/or the FIA Heritage Certificate and/or Fiche ACI Sport and/or the FIA HTP are required.
- 6.6.10** Race cars will be registered with Make and Model and year of manufacture referred exclusively to the mentioned documents.
- 6.6.11** The cars entered must comply with the periodic revision of the vehicles if required and in accordance with the provisions of the laws of the country of registration. If the country of registration does not provide for the periodic revision of the cars, the competitor must produce a self-declaration in which he must declare the lack of need for revision according to the laws of the country of registration and consequently, he will declare to be able to circulate in his own country of origin having undergone all the technical checks to demonstrate the perfect efficiency of the car and all its devices. In the absence of this document the crew will not be able to pass the administrative checks.
- 6.6.12** The cars must also meet all the requirements to circulate within Italian territory.

6.7 REPLACEMENT OF A RACE CAR

6.7.1 CONDITIONS FOR SUBSTITUTION

Until 16:00 on Friday 15th May 2026, the replacement of a car accepted or inserted in the waiting list is allowed. A car accepted or included in the Waiting List may be replaced, subject to payment according to the provisions of article 6.7.2 below and subject to the approval of the Organiser, only with another car that meets all the requirements of these SRR according to the TDC (Coefficient Tables) 1000 Miglia 1927-1957.

In case of non-acceptance of the entry, in order to obtain the acceptance, the Competitor will not be able to request the replacement of the car. This provision does not apply to entries for Sponsor Team cars.

It will not be possible to replace the car if both crew members have already been replaced. This provision does not apply to entries for Sponsor Team cars.

6.7.2 REQUIREMENTS FOR REQUESTING THE SUBSTITUTION OF A RACE CAR

In order to request the replacement of a car, the Competitor must send the appropriate form made available to the Organiser on the Website by e-mail to participants@1000miglia.it with a request for acceptance by the receiver and followed by confirmation of receipt by the receiver attaching the documentation in the form. Competitors provided with certified e-mail (PEC) must send the abovementioned notice to the PEC address: 1000miglia@legalmail.it.

The substitution of the race car requires the mandatory payment of € 2.440,00 (i.e. € 2000,00 + VAT 22%) for administrative fees, payable to the IBAN number stated on the car substitution form. In the absence of such payment, the request for substitution will not be taken into consideration. The Organiser will contact the competitor within 10 days from receipt of the request for substitution, accompanied by the bank transfer.

6.8 COEFFICIENTS ASSIGNED TO RACE CARS

In order to compensate and equate technical and performance characteristics of the race cars in the race, correction coefficients will be assigned based on the design and period of construction of the vehicle. The coefficients assigned are described in the table attached to these SRR.

The coefficient assigned to each accepted race car will be published by Friday 3 April 2026; each competitor may submit other documentary integrations aimed at the definitive assigning of a coefficient, within 15

days from the date of publication. No exceptions will be allowed to the terms stated above.

All race cars accepted in the "Special List" will be assigned a coefficient of 1.00. In addition, will be assigned a coefficient of 1.00 all race cars accepted with Platinum fee (art. 8.10.4) who will be registered after the deadline set out in art. 8.3.1 but by 30 April 2026.

All cars belonging to the E.R. (Educational Reconstruction) category will be assigned a coefficient of 0 (Zero).

6.8.1 The use of a temporary number plate is always prohibited, under penalty of immediate exclusion.

6.8.2 The following are always prohibited, subject to a penalty which may include exclusion, at the Stewards discretion:

- a) the installation and use of any protrusion from the bodywork, not envisaged by the Manufacturer, which has the purpose of sighting the intermediate split lines;
- b) installing or implementing viewfinders with adhesive material, inside or outside the vehicle, having dimensions larger than 15 cm in length and 2 cm in width;
- c) the presence of adhesive viewfinders on race number plates, on the Organiser's advertising stickers and on race number plates.

7. RACE NUMBER AND STARTING ORDER

7.1 The assignment of race Numbers, valid also for drawing up the Starting Order in relation to the increasing order of the numbers assigned, excepting for specific organisational requirements, will comply with the following criteria:

- series 1: cars make OM;
- series 2: cars in increasing order of year of manufacture.

7.2 Race numbers chosen at the discretion of the organiser can be assigned using specific procedures with public procurement procedures set up as required by the organiser.

7.3 The assignment of race numbers that follow one another can be requested, only for race cars that are part of the "Sponsor Team".

The assignment of numbers will be as follows:

- a) division of cars into blocks of:
 - cars built pre 1945
 - cars built post 1945
- b) inside each block, in the order according to the year of manufacture;
- c) the positioning of the block of vehicles, in starting order, according to the average from the years of manufacture of the vehicles included in the same block.

7.4 Subject to special organisational requirements, cars entered with Platinum quota shall be allocated a race number, which, taking into account the year of production of the entered car, shall be included among the first two hundred race numbers.

7.5 Vehicles in the waiting list (cfr Article 8.16) will leave according the race number assigned by the organiser who will, as far as possible, comply with the criteria stated in the previous points of this article.

8. ENTRIES

8.1 By signing the entry application form, the Competitor and Drivers undertake to submit only to the sporting jurisdictions recognised by the International Sporting Code and to the provisions of these SR.

Presentation of the entry form does not give the right to participate in the race as the organiser will select the requests and accept entries in his unquestionable judgement.

The organisers will not be required to motivate the reason for exclusion, nor will the said exclusion allow for the request for damages and/or refund of expenses, excepting for the return of the deposit (Art. 8.3 of these SR).

8.2 METHODS OF ENTRY

Entry applications may only be submitted via the Website www.1000miglia.it.

The presentation date of each competitor's entry application coincides with the date on which the sum provided for in art. 8.3 below is credited to the bank account in the name of the Organiser. Entry must be formalized according to the days and times indicated in the Programme of these SR.

Acceptance of the entry application will be announced to the Competitor according to the terms and conditions set out in these SR.

8.3 ENTRY GUARANTEE DEPOSIT

8.3.1 Payment of € 10.736,00 (Vat included) or € 15.860,00 (Vat included) or € 18.300,00 (Vat included) or € 22.570,00 (Vat included) or € 73.200,00 (Vat included), depending on the selected service package, valid as a deposit for entry of the car and team must be made in one of the following ways:

- a) by Credit Card (only VISA - MASTERCARD) by 16:00 (GMT+1) on Thursday 15 January 2026.
- b) by bank transfer to the coordinates indicated in the entry form, with maximum credit value on the 1000 Miglia S.r.l. current account by 16:00 (GMT+1) on Thursday 15 January 2026.

The date that payment is credited to the Organiser's bank account, and not the date of the payment order, will be considered valid for entry.

For competitors using a bank account of a nationality other than Italian, entry requests will be considered valid - subject to verification by the Chief Executive Officer - if payment is made by the deadline set out in Article 8.3.1 of these Regulations, but with the date of actual credit to the Organiser's bank account no later than 7 (seven) days from the aforementioned deadline.

8.3.2 Teams that enter according to the provisions of sponsorship contracts as per Article 6.3 of these SRR will be subject to the following conditions of the said article:

- a) The closing date for presentation of entry and crediting of the bank transfer or payment by credit card will be Thursday 12 February 2026 at 16:00 (GMT +1).
- b) The final deadline for crediting the entire amount of the deposit onto the current account of 1000 Miglia S.r.l., to be made by bank transfer or credit card, is Thursday 12 February 2026 without prejudice to payments made within the above terms.

8.4 REQUEST FOR ENTRY OF A "SPONSOR TEAM"

In order to inform the Organizer of the willingness of a sponsor entitled to exercise the "Sponsor Team" option, the specific application form signed by the legal representative of the Sponsor must be sent, confirmed by e-mail by the Competitors of the identified cars, no later than 4:00 p.m. (GMT+1) on Thursday 26 February 2026, to participants@1000miglia.it with a request for acceptance by the receiver and followed by confirmation of receipt by the receiver.

Competitors with certified electronic mail (PEC) must send the abovementioned notice to the PEC address: 1000miglia@legalmail.it.

8.5 REQUEST TO ENTER A "GUEST CAR"

In order to inform the Organizer of the will of a Sponsor entitled to exercise the Guest Car option, the specific application form must be sent no later than 12:00 pm (GMT+1) on Thursday 30 April 2026 to participants@1000miglia.it with a request for acceptance by the receiver and followed by confirmation of receipt by the receiver.

Competitors with certified electronic mail (PEC) must send the abovementioned notice to the PEC address 1000miglia@legalmail.it.

8.6 METHOD TO PRESENT AND WITHDRAW THE REQUEST TO ENTER A SPONSOR "GUEST CAR"

In order to activate the "Guest Car" option for a car being part of a Sponsor's contingent, in addition to the provisions of art. 8.5, the Competitor must submit to the Organisers, according to the modalities and times indicated in art. 8.3.2, an additional deposit of € 15.860,00 (VAT included) or € 18.300,00 (VAT included) or € 22.570,00 (VAT included) depending on the service package chosen [see art. 8.11 of these SR] for each car designated as a "Guest Car", regardless of the number of Drivers taking part in the event.

8.7 ACCEPTABILITY OF ENTRY REQUESTS

Registration applications must be complete with all the documentation required by the application prepared by the organizer 1000 Miglia S.r.l. on its website www.1000miglia.it.

Failure to pay the deposit means the request for entry will not be taken into consideration.

Requests which are untrue, incomplete, without documentation or with amounts owing to the organisation,

will not be taken into consideration.

The Organisers reserve the right, at their sole discretion, not to accept to the race those cars whose Drivers were penalised during previous editions of the 1000 Miglia race.

8.8 ACCEPTANCE OF ENTRY

By Friday 3 April 2026, each team will be able to verify online, inside its own reserved area, whether or not the entry for the race has been accepted. Confirmation will nonetheless be sent also to the e-mail address indicated in the relative area of the entry form.

To complete entry, it will be necessary to enter the Bank details in the relative section of the on-line form, for the return of the fee, if necessary.

8.8.1 Entry requests for cars received from competitors who have not provided all the technical documentation required by these SRR or by the Registro 1000 Miglia Regulations may be accepted with the formula sub iudice: in this case, the car may only be accepted if the competitor has provided all the required documentation, or if they have made the modifications communicated by the Registro 1000 Miglia no later than 30 April 2026.

Competitors with cars accepted sub iudice who have supplemented the required documentation by the deadline specified in Article 8.8.1 may be accepted to the administrative and technical checks only if they have obtained the Provisional or Definitive Certificate of the Registro 1000 Miglia for those same cars. Any exceptions will be considered by the Board of Directors

8.9 FINALISING ENTRY

Entry is understood as being finalised only on acceptance of the entry request by the organiser and to the allocation of the sum paid as a deposit in the sum paid as an entry fee.

After the car has been accepted at the event, 1000 Miglia S.r.l. will issue a regular invoice, using the data requested during the entry phase.

By presenting the request for entry, the applicant authorises the organiser to consider the amount paid previously as a deposit, as an entry fee in the case of acceptance of the request for entry.

8.10 ENTRY FEE

The following entry fees are envisaged:

8.10.1 **BASIC ENTRY IN DOUBLE ROOM**

The basic entry fee in a double room amounts to € 13,000.00 plus 22% VAT (total € 15,860.00) and includes:

- a) Participation in the race after selection of the car:
 - kit of documents and technical materials provided;
 - standard passes;
 - 2 Welcome bags.
- b) Hospitality for a crew of two persons, including:
 - 4 nights (9th -10th - 11th - 12th June 2026) in a double room (not more than 4 stars) with breakfasts;
 - 5 light buffet lunches per person;
 - 4 light dinners per person;
 - Prize-giving ceremony for the driver and co- driver.
- c) Services included in the entry:
 - 4 Admissions to the Paddocks (including driver and co-driver and any mechanics / guests);
 - Possibility to purchase additional service packages.

8.10.2 **SILVER 1000 MIGLIA ENTRY DOUBLE ROOMS**

The Silver entry fee is € 15.000,00 plus 22% VAT (total € 18.300,00) and includes:

- a) Participation in the race after selection of the car:
 - kit of documents and technical materials provided;
 - "Silver" Pass;
 - 2 Silver Welcome bags with dedicated Merchandising
- b) Hospitality for a crew of two, including:
 - 6 nights (7th - 8th - 9th - 10th - 11th - 12th June 2026) in a hotel in a double room (category not exceeding 4 stars) with breakfast;
 - 5 light buffet lunches per person;
 - 4 light dinners per person;

- Prize ceremony for driver and co-driver.
- c) Services included with entry:
 - 4 Accesses to the Paddock (including driver and co-driver and any mechanics / guests);
 - Dedicated check-in service at the Paddock (dedicated queues)
 - Possibility to purchase additional service packages.

8.10.3 **GOLD ENTRY IN SINGLE ROOMS**

The gold entry fee in 2 single rooms amounts to € 18,500.00 plus 22% VAT (total € 22,570.00) and includes:

- a) Participation in the race after selection of the car:
 - kit of documents and technical materials provided;
 - "Gold" passes;
 - 2 Welcome bags with dedicated Merchandising.
- b) Hospitality for a crew of two persons, including:
 - 6 nights (7th - 8th - 9th - 10th - 11th - 12th June 2026) in two single rooms (not more than 4 stars) with breakfasts;
 - 5 light buffet lunches per person;
 - 4 light dinners per person;
 - Prize-giving ceremony for the driver and co-driver.
- c) Services included in the entry:
 - 4 Admissions to the Paddocks (including driver and co-driver and any mechanics/guests);
 - Dedicated check-in service at the Paddock (dedicated queues);
 - Possibility to purchase additional service packages.

8.10.4. **PLATINUM 1000 MIGLIA ENTRY "GUEST CAR" FORMULA**

Available for a maximum of 8 entries accepted according in order of time together with the payment of the security deposit. The Platinum entry fee amounts to € 60,000.00 plus 22% VAT (total € 73,200.00) and includes:

- a) Participation in the race after selection of the car:
 - Automatic acceptance of the race without selection, after possession of an eligible vehicle (Article 6.6 of these SR);
 - Participation in the "Guest-Car" Formula Race - 6 admitted drivers with the right to exchange (Article 6.5 et seq. of this SR) and separate classification;
 - kit of documents and technical materials required for the car in the race;
 - kit of documents and technical materials provided (Access Historical Centers) for the car in tow;
 - "Platinum" pass;
 - 6 Welcome bags Platinum with specific Merchandising.
- b) Hospitality for a crew of 6 people, including:
 - 7 nights (7th - 8th - 9th - 10th - 11th - 12th - 13th June 2026) in 3 double-rooms (max. 6 people) – 5-star hotel (excluding Rome 4 with breakfast);
 - 5 light lunches for 6 people;
 - 4 light dinners for 6 people;
 - Prize-giving ceremony for 6 people or Dinner at the respective Hotels;
- c) Services included in the entry:
 - 8 Admissions to the Paddocks (including driver and co-driver and any mechanics / guests);
 - Specific parking at the Paddock;
 - Dedicated check-in service at the Paddock (dedicated queues);
 - Possibility to purchase additional service packages.

8.10.5 **YOUNG ENTRY IN DOUBLE ROOM**

The Young double room entry fee, reserved only for crews composed of 2 drivers under 30 years of age who have not reached the age of 31 on the end date of the race, amounts to € 8.800,00 plus 22% VAT (total € 10.736,00) and includes:

- a) Participation in the race after selection of the car:
 - kit of documents and technical materials provided;
 - standard passes;
 - 2 Welcome bags.
- b) Hospitality for a crew of two persons, including:
 - 4 nights (9th - 10th - 11th - 12th June 2026) in a double room (not more than 4 stars) with

- breakfasts;
 - 5 light buffet lunches per person;
 - 4 light dinners per person;
 - Prize-giving ceremony for the driver and co- driver.
- c) Services included in the entry:
- 4 Admissions to the Paddock (including driver and co-driver and any mechanics/ guests);
 - Possibility to purchase additional service packages.

Payment of the Young entry fee will not entitle participants to receive any gifts distributed directly by the Sponsors.

8.10.6 STATE BODIES ENTRY IN DOUBLE ROOM

The State Bodies double room entry fee, reserved exclusively for crews belonging to Military and Civil Bodies of the Italian State, or for crews composed of at least 1 driver belonging to the National Union of Italian Retired Officers (UNUCI), amounts to € 8.800,00 plus 22% VAT (total € 10.736,00) and includes

- a) Participation in the race after selection of the car:
- kit of documents and technical materials provided;
 - standard passes;
 - 2 Welcome bags.
- b) Hospitality for a crew of two persons, including:
- 4 nights (9th - 10th - 11th - 12th June 2026) in a double room (not more than 4 stars) with breakfasts;
 - 5 light buffet lunches per person;
 - 4 light dinners per person;
 - Prize-giving ceremony for the driver and co- driver.
- c) Services included in the entry:
- 4 Admissions to the Paddocks (including driver and co-driver and any mechanics/ guests);
 - Possibility to purchase additional service packages

Payment of the State Bodies entry fee will not entitle participants to receive any gifts distributed directly by the Sponsors.

- 8.10.7** The payment of the entry fee for a car that is registered for cultural purposes or belongs to the R.D. category will not entitle participants to receive any gifts distributed directly by the Sponsors.

8.11 ADDITIONAL ENTRY FEE SPONSOR "GUEST CAR"

The additional entry fee for the Sponsor "Guest Car", to be paid in addition to the amount already paid for the entry of the car as per Article 8.10, may be chosen by the Sponsor from one of the following packages.

8.11.1 ADDITIONAL ENTRY FEE SPONSOR "GUEST CAR" BASIC:

The extra-entry fee for the Basic Sponsor "Guest Car", in addition to the amount paid depending on the chosen service packages under Section 8.10, amounts to € 13,000.00 plus VAT 22% (total € 15.860,00) and includes, in addition to the services already listed in Article 8.10:

- a) Participation in the race of the car:
- Participation in the "Guest-Car" Formula Race - 4 additional admitted drivers with the right to exchange (Article 6.5.3 et seq. of this SRR) and separate classification;
 - kit of documents and technical materials provided (Access Historical Centres) for the car following.
 - 4 Welcome bags.
- b) Hospitality for a crew of 4 persons, including:
- 4 nights (9th - 10th - 11th - 12th June 2026) in 2 double rooms (max 4 persons) - hotel category not more than four stars with breakfasts;
 - 5 light buffets lunches per 4 people;
 - 4 light dinners for 4 people;
 - Prize-giving ceremony for 4 people.
- c) Services included in the entry:
- 4 Admissions to the Paddock;
 - Possibility to purchase additional service packages.

8.11.2 ADDITIONAL ENTRY FEE SPONSOR "GUEST CAR" SILVER:

The extra-entry fee for the Silver Sponsor "Guest Car", in addition to the amount paid depending on the chosen service packages under Section 8.10, amounts to € 15,000.00 plus VAT 22% (total € 18.300,00) and includes, in addition to the services already listed in Article 8.10:

- a) Participation in the race of the car:
 - Participation in the "Guest-Car" Formula Race - 4 additional admitted drivers with the right to exchange (Article 6.5.3 et seq. of this SRR) and separate classification;
 - kit of documents and technical materials provided (Access Historical Centres) for the car following.
 - 4 Welcome bags Silver with dedicated Merchandising.
- b) Hospitality for a crew of 4 persons, including:
 - 6 nights (7th - 8th - 9th - 10th - 11th - 12th June 2026) in 2 double rooms (max 4 persons) - hotel category not more than four stars with breakfasts;
 - 5 light buffets lunches per 4 people;
 - 4 light dinners for 4 people;
 - Prize-giving ceremony for 4 people.
- c) Services included in the entry:
 - 4 Admissions to the Paddock;
 - Possibility to purchase additional service packages.

8.11.3 ADDITIONAL ENTRY FEE SPONSOR "GUEST CAR" GOLD:

The extra-entry fee for the Gold Sponsor "Guest Car", in addition to the amount paid depending on the chosen service packages under Section 8.10, amounts to € 18,500.00 plus VAT 22% (total € 22.570,00) and includes, in addition to the services already listed in Article 8.10:

- a) Participation in the race of the car:
 - Participation in the "Guest-Car" Formula Race - 4 additional admitted drivers with the right to exchange (Article 6.5.3 et seq. of this SRR) and separate classification;
 - kit of documents and technical materials provided (Access Historical Centres) for the car following.
 - 4 Welcome bags Gold with dedicated Merchandising.
- b) Hospitality for a crew of 4 persons, including:
 - 6 nights (7th - 8th - 9th - 10th - 11th - 12th June 2026) in 4 single rooms (max 4 persons) - hotel category not more than four stars with breakfasts;
 - 5 light buffets lunches per 4 people;
 - 4 light dinners for 4 people;
 - Prize-giving ceremony for 4 people.
- c) Services included in the entry:
 - 4 Admissions to the Paddock;
 - Possibility to purchase additional service packages

8.12 REFUND OF THE ENTRY FEE FOR CREWS NOT ACCEPTED

In the case of non-acceptance and/or non-inclusion on the waiting list of a car by the organiser, the deposit will be refunded by bank transfer or accredited on the credit card, by Wednesday 3 June 2026.

8.13 HOW TO WITHDRAW THE APPLICATION FORM OR ENTRY

In all cases:

- the request for withdrawal of the entry application, i.e. the entry, must be sent by e-mail to participants@1000miglia.it with a request for acceptance by the recipient and followed by confirmation of receipt by the recipient himself. Competitors provided with certified e-mail (PEC) must send the abovementioned notice to the PEC address: 1000miglia@legalmail.it;
- if due, the refund of the entry fees will take place within 60 (sixty) days following the announcement date of the withdrawal.

8.14 REFUND OF THE ENTRY FEE IN CASE OF WITHDRAWAL OF THE ENTRY APPLICATION OR THE ACCEPTED ENTRY

Except as otherwise provided in Article 8.22 below, in the event of withdrawal, for any reason, of the entry application or the accepted entry by a Competitor, the entry fees shall be refunded only as follows:

From: opening date for entries To: closing date for entries	The fee paid as deposit by the Competitor shall be entirely refunded to the latter, net of administrative charges in the amount of Euros 200.00 plus VAT equal to 22%;
From: the day following the closing date for entries To: publication of list of Competitors and cars accepted	The fee paid as a deposit by the Competitor shall be entirely refunded to the latter, net of a penalty equal to Euro 1.250.00 (VAT exempt pursuant to article 15, paragraph 1, Italian Presidential Decree 633/72);
From: the day following the publication of the list of Competitors and cars accepted To: Thursday 23 th April 2026	The entry fee paid by the Competitor will be refunded in full to the Competitor, less a deduction for secretarial and management fees of 50% of the fee paid plus VAT at 22%.
From: Friday 24 th April 2026 To: Friday 15 th May 2026	The entry fee paid by the Competitor will be refunded in full to the Competitor, less a deduction for secretarial and management fees of 75% of the fee paid plus VAT at 22%.
From: Saturday 16 th May 2026	The entry fee shall not be refunded

8.15 FAILURE TO PASS ADMINISTRATIVE CHECKS

In the case of failure to pass the administrative checks and/or scrutineering, the competitor will not have the right to the refund of the entry fee paid, but will retain the right to make use of the hospitality envisaged for the team and any gifts and gadgets distributed directly by the sponsors, as per Article 8.10 et seq. of these SSR. This right shall be guaranteed only if the competitor or a crewmember with proxy signed by the competitor are present at the pre-race administrative checks. Therefore, if Competitors or drivers authorised by the same, are not present at the pre-race checks, they will not be entitled to the refund of the entry fee, nor will they be allowed to enjoy the hospitality provided for the crew or any benefactor facilities reserved to the participants.

8.16 WAITING LIST

The "Waiting List" is an instrument that allows the competitors entered for the event, but not accepted by the Organiser by the publication of the list of those admitted, to participate in the race by replacing crews that have withdrawn or have not passed the checks for any reason.

At the presentation of the request for entry, every competitor must state his acceptance to be placed on the "Waiting list".

The waiting list will be made up of the cars that:

- a) satisfy all eligibility requirements, as contained in these SR;
- b) have not been accepted as per the publication of the list of those admitted;
- c) belong to competitors who have provided their willingness to be part of such list.

Should a competitor accepted for the race as from publication of the list of competitors and cars admitted notify his withdrawal from the race, the organiser, at his sole discretion, will select one.

Competitors included in the Waiting List will have the possibility to accept or refuse the proposal by replying to participants@1000miglia.it within 72 hours from the announcement. Competitors provided with certified e-mail (PEC) must send the abovementioned notice to the PEC address: 1000miglia@legalmail.it.

Acceptance by the Organisation will allow the team to be registered for the race in compliance with Article 8.9 of these SR.

In case of non-acceptance by the Competitor of the proposal for participation, the amount paid by the Competitor as a guarantee deposit will be refunded in full net of secretarial costs of € 400,00 plus 22% VAT.

8.17 LIST OF CARS ON THE "WAITING LIST"

There are no lists for the cars on the waiting list. The replacement of crews that have withdrawn will be at the unquestionable discretion of the organiser.

8.18 CLOSURE OF THE "WAITING LIST"

The "Waiting list" will close on Wednesday 3th June 2026 at 16:00.

By the said date, the Organiser will inform those teams on the "Waiting list" whether they have been accepted for the race, or not, by e-mail directly to the address stated in the relative section of entry form.

- 8.18.1** The organiser has the right to contact competitors on the "Waiting List" in the case of withdrawal, from Thursday 4th June to Sunday 7th June 2026 at 10:00.

Competitors included in the Waiting List will have the possibility to accept or refuse the proposal by replying to participants@1000miglia.it within 24 hours from the announcement. Competitors provided with certified e-mail (PEC) must send the abovementioned notice to the PEC address: 1000miglia@legalmail.it.

Acceptance by the Organizer will result in the Crew entering the race in accordance with and for the purposes of Article 8.9 of these SRR.

In case of non-acceptance by the Competitor of the proposal for participation, the amount paid by the Competitor as a guarantee deposit will be refunded in full.

- 8.18.2** Notwithstanding the maximum limit of 8 (eight) entries as per Article 8.10.4, as an exception to the provisions of Article 8.3, entry requests with "PLATINUM" fee may be accepted, at the sole and indisputable discretion of the Organisers, until Thursday 30 April 2026 – 4:00 pm. To the participants entry with Platinum fee after the term per article 8.3.1 but by 30 April 2026, will be assigned a coefficient as 1,0 (cfr art 6.8).

8.19 ADMISSION TO THE RACE DURING THE PRE-RACE VERIFICATION

Albeit without any guarantee of participating, competitors on the "Waiting list" will be able to be present at administrative checks on Tuesday 9th June 2026, from 07:30 to 08:30. After having entered, they have the possibility of being admitted to the race after scrutineering, at the unquestionable judgement and discretion of the organiser.

Acceptance can only take place in replacement of entered crews who have not passed scrutineering.

The crews coming from the "Waiting List" will not be entitled to any benefit or facilitation recognized to the participants, they will be entitled exclusively to the services related to the basic package as per art. 8.10.1). If the competitors accepted from the waiting list had paid the entry fee of the Silver or Gold package, the partial refund of the security deposit will take place within 60 days following the date of withdrawal and in any case no later than Friday 24th July 2026.

Acceptance will require the entry of the crew to the race, pursuant to and for the purposes of Article 8.9 of these SR.

- 8.19.1** The competitors who replace others during the scrutineering phase will be selected from among the registered crews, based on the following priority criteria:

- a) in substituting, priority will be given to a vehicle from the same period as the one substituted;
- b) with equal requisites, the competitor coming from further away will be selected.

8.20 NOTIFICATION OF WITHDRAWAL OF ENTERED CARS ON THE "WAITING LIST"

The withdrawal of the entry application by the competitor included in the Waiting List must be sent by e-mail to participants@1000miglia.it with a request for acceptance by the receiver and followed by confirmation of receipt by the receiver. Competitors with certified e-mail (PEC) must send the abovementioned notice to the PEC address 1000miglia@legalmail.it.

8.21 REFUND OF DEPOSIT FOR VEHICLES ON THE "WAITING LIST"

The refund of the deposit in the case of withdrawal by a competitor of a vehicle on the waiting list, will only occur in compliance with what is stated in Article 8.13 of these SR, applying administrative fees of € 400,00 plus VAT.

If owed, the deposit fee will be refunded within 60 days from the date of notification of the withdrawal, and nonetheless within and no later than Friday 24th July 2026.

It remains firm that competitors who do not withdraw and are not selected from the "Waiting List" have the right to be refunded in full for the amount paid by bank transfer or accredited on their credit card by Friday 24th July 2026.

8.22 POSTPONEMENT OF THE EVENT DUE TO FORCE MAJEURE

The Organiser reserves the right, at any time and at its sole discretion, to postpone the Event if an extraordinary event qualifying as a Force Majeure circumstance occurs, or, for the occurrence of extraordinary and unforeseeable events, not dependent on its will, which may directly or indirectly

influence the ordinary running of the event, such as, but not limited to, health emergencies, epidemics, pandemics, measures taken by the Public Authorities, earthquakes, landslides, floods or, in general, any other natural disaster that makes it impossible to hold all or part of the Event.
For any requests to withdraw entry, the conditions set out in art. 8.14 shall apply according to the new deadlines that will be communicated.

8.23 CANCELLATION OR SUSPENSION OF THE EVENT DUE TO FORCE MAJEURE

The Organiser reserves the right, at any time and at its sole discretion, to cancel and/or suspend the Event if an extraordinary event qualifying as a Force Majeure circumstance occurs, or, for the occurrence of extraordinary and unforeseeable events, beyond its control that may directly or indirectly influence the ordinary course of the event, such as, by way of example but without any limiting intent, health emergencies, epidemics, pandemics, measures by the Public Authorities, earthquakes, landslides, floods or, in general, any other natural calamity that makes it impossible to hold all or part of the Event.

In case of cancellation or suspension of the Race, the Organiser shall refund the entry fees as follows:

From: opening date for entries To: closing date for entries	The fee paid as a deposit by the Competitor shall be entirely refunded to the latter;
From the day following the closing date for entries To: Saturday 2 nd May 2026	The fee paid as a deposit by the Competitor shall be entirely refunded to the latter net of administrative charges in the amount of Euros 250.00 plus V.A.T. equal to 22%;
From: Sunday 3 th May 2026 To: Friday 22 th May 2026	The fee paid as a deposit by the Competitor shall be entirely refunded to the latter net of a deduction as administrative and management costs equal to 10% of the fee paid plus VAT at 22%
From: Saturday 23 th May 2026 To: Monday 1 st June 2026	The fee paid as a deposit by the Competitor shall be entirely refunded to the latter net of a deduction as administrative and management costs equal to 20% of the fee paid plus VAT at 22%
From: Tuesday 2 nd June 2026 To: Saturday 6 th June 2026	The entry fee shall be refunded to the extent of 50% plus VAT equal to 22%;
From: Sunday 7 th June 2026	The entry fee shall not be refunded

In case of postponement of the race, the aforementioned time limits will be extended.

Competitors included in the Waiting List shall be subject to the provisions of Article 8.21; Competitors who have not been accepted shall be subject to the provisions of Article 8.12 of these SRR.

9. GENERAL OBLIGATIONS

9.1 ADMINISTRATIVE CHECKS

Competitors and drivers must be present in person and with the accepted car, failure to do so will imply the impossibility of passing the checks and therefore of participating in the race, in the ways and means established in the programme. The Sports Inspectors and Road Traffic Police will undertake the following checks and formalities:

- a) checking of mandatory documents for competitors and drivers to be presented in original copy:
 - valid driving license, national and international;
 - sports licence of the nation of belonging or Italian daily licence;
 - medical certificate (Attached 1 of these SR);
 - valid race car insurance RCA;
 - race car registration papers.
 - possible declaration of non-necessity of periodic revision of the vehicle according to the laws of the country of registration of the vehicle.
- b) hand out and apply the Personal Identification Device (CPI) described in Article 9.2 of these SR;
- c) sign, for acceptance, the check forms drawn up by the organiser and the Road Traffic Police;

The procedures for carrying out the administrative checks may be totally or partially dematerialised according to the regulations prepared by the ASN and national or territorial government Bodies.

9.2 PRE ADMINISTRATIVE CHECKS AND SCRUTINEERING

The abovementioned documents must be uploaded by participants by Friday 15th May 2026 into their reserved area of the entry system. Failure to upload even a part of the documents referred to in Article 9.1 may lead to penalisation of competitors up to exclusion from the race

9.3 PERSONAL IDENTIFICATION DEVICE (CPI)

During the administrative checks, a Personal Identification Device (CPI) will be applied to each driver, in order to identify clearly the participant for the entire duration of the event.

The staff delegated by the organiser will be responsible for the application of this device and this cannot be refused by the driver.

The device cannot be ceded and cannot be removed until the end of the race on penalty of exclusion from the race.

The exhibition of the (CPI) can be requested by Officials or by escorting Road Traffic Police, at any moment. The absence of the sticker can result in the exclusion of the crew and the car from the race.

In the case of breakage or loss of the (CPI) the driver must first notify it to the first Competitor Relations Officer he finds along the route.

9.3.1 Only members of crews who have passed the pre-race administrative checks can participate in the race. No exchanges of authorised drivers are allowed between cars in the race.

Should persons other than those who have passed the pre-race administrative checks be found onboard a race car during the race, except for the transport of an injured person, the car and its driver will immediately be excluded from the race; this also does not exclude further penalties to be decided at the discretion of the Stewards.

9.4 RACE NUMBER STICKERS

At the administrative checks, each competitor will receive a Sticker Kit consisting of:

- 3 round number holder stickers, with the race number and the Organizer's advertising;
- 2 series of pre-spaced fluorescent race numbers.

9.4.1. APPLYING THE RACE STICKERS TO THE CARS

Cars must be presented for technical checks with all the kit stickers mentioned in Article 9.3 of these SRR already applied, according to the following instructions:

- a) 1 round number holder sticker for each side of the race car on the front doors (in cars with doors) or on the front sides (on cars without doors or with small doors);
- b) 1 round number holder sticker on the front bonnet of the race car;
- c) 1 pre-spaced fluorescent number on the front windshield positioned to allow it to be seen when looking at the front part of the race car;
- d) 1 pre-spaced fluorescent number on the rear window: should this not be possible the sticker must be applied on the rear boot in such a way as to allow it to be visible looking at the back of the race car;

The guide layout is provided attached to these SRR, for the correct positioning of the race numbers (Appendix 2).

Should it not be possible to apply all three of the round number holder stickers that are distributed, on the cars due to lack of space, it will be possible to apply only 2 stickers. In this case, the third sticker must be returned to the Organisation at the technical check, failure to do so could result in exclusion from the race.

9.5 SCRUTINEERING

After having passed all the administrative checks, the crews must submit the cars to scrutineering, in the ways and times stated in the programme. Failure to do so will lead to the cars being excluded from the race. Checks will be as follows.

- a) checking the correct positioning of the stickers referred to in Article 9.4.1 of these SRR, checking the correct functioning of the sound (horn) and light signalling devices suitable for road traffic, as well as checking the actual possession of emergency signalling devices in the event of road accidents, such as a warning triangle and reflective vest;
- b) check of the following documents, to be presented as originals:
 - Registro 1000 Miglia Certificate
 - FIVA International Identity Card and/or FIA Heritage Certificate and/or valid ACI Sport Fiche and/or HTPFIA concerning the race car, all valid;
 - check that notified data correspond with registration data (year of manufacture and chassis number);

- c) placing of safety equipment as per Article 9.7 of these SRR.

By carrying out the administrative and technical checks, 1000 Miglia S.r.l. shall not be held liable for the actual compliance of the cars checked with the current Italian regulations for road circulation, nor for their correct maintenance conditions; competitors and drivers shall therefore remain solely liable.

9.6 SEALING

At the end of the technical checks the cars tested must be driven, by the Competitor or his delegate, to the stamping that will take place in Piazza Vittoria in Brescia in the manner and within the timeframe specified in the programme.

Free entry is allowed in Piazza Vittoria, but competitors will be able to access the stamping area by following the escort prepared by the Organizer and carried out by the Brescia Local Police according to the following service hours:

- a) from 10:00 to 20:00 on Monday 8 June 2026;
- b) from 07:30 to 10:00 on Tuesday 9 June 2026.

Each competitor is required to respect the day and time assigned to them at the end of the technical checks for participation in the escort that will lead to the stamping.

During stamping, the Scrutineers will apply a "lead" to the steering column or another non movable part of the race car and will also apply a "Checked" sticker that cannot be removed, onto the car. Removal will result in the car being excluded from the race.

Once the Competitor has passed the sealing, they shall be considered to have been verified, accepted and to have started: any withdrawal from the competition, for any reason whatsoever, shall not entitle the Competitor to a refund of the entry fee and of any supplements purchased. The withdrawn crew may however continue to benefit from the hospitality services associated with the Event.

9.7 SAFETY EQUIPMENT

The GPS-Tracker equipment supplied by the organiser must remain installed on the racecar for the entire duration of the race. The equipment must be returned to the CO/TC at the final arrival.

The device will be pre-installed during the scrutineering by company engineers (a strip of Velcro will be applied on the vehicle to fix the device) and all necessary information as well as a use manual for the device will be provided, as well as a release form for the use of data recorded on the device itself.

The "GPS-Tracker" will track compliance to the route of the race by the team and will also record the speed of the car. Recorded data will be available to the race Directors and Stewards in order for them to take disciplinary action against the competitors who have broken the Road Safety Rules and the race regulations, aside from any other provisions that could be taken by Police Officers who have detected an infringement of the law. Data could be made available following a request by the legal authorities.

The data recorded by means of the GPS - Tracker equipment installed on all cars entered in the event shall be made available exclusively to the competent Public Authorities.

In the case of loss or malfunction of the GPS-Tracker, the competitor will notify this to the Competitor Relations Officer at every T.C. or those responsible for technical devices present at every lunch break and every arrival/start of each Leg.

In the case of withdrawal of a competitor along the route of the various Legs, the GPS-Tracker will be returned to the Competitor Relations Officers or to the persons responsible for this in the Technical Support Convoy (Technical Car and Pace Car).

9.8 OBLIGATIONS OF COMPETITORS - RULES OF CONDUCT

Throughout the event, drivers must drive prudently and carefully, scrupulously respect the Italian Road Traffic Law and instructions given by the Clerk of the course and by Officials.

The Officials - those in Charge (Article 2.4 of these SR) positioned in the Technical Support convoy (teams in the Front Car, Pace Car and Technical Car), Road Traffic Police Officers will notify violations and offences of the Regulations, and the Instructions stated above.

In the case of infringements, the Clerk of the course will notify the Stewards who will apply the following penalties:

- first offence: 1.000 negative penalty points;
- second offence: 12.000 negative penalty points;

Depending on the seriousness of the offence, the Stewards will apply the penalties up to exclusion from the event, even after only one offence.

In each Leg, the CoC can undertake speed checks on all the cars in the race. The Officials along the route as well as all the cars in the Technical Support convoy and Road Traffic Police Officers will also be responsible for supervising the conduct of the competitors and their service and team vehicles, notifying the Clerk of the course of any offence but without taking any independent decisions.

Also, Road Traffic Police Officers and local Police Members in the relative areas can notify the CoC of any offences by competitors and their service and team vehicles.

Driving behaviour should always be prudent for oneself, for Officials, and especially for spectators.

Each competitor is always responsible also for the behaviour of their service and team vehicles, which must necessarily strictly observe the instructions given by Officials and Marshals and must follow the route envisaged in the Road book in some parts of the race route. Failure to comply with this provision will result in sanctions against the relevant competitor, and may even lead to expulsion from the race, at the Stewards' discretion. It is absolutely forbidden for all members of the Crew to: (i) drink alcohol starting from 6 (six) hours before the departure of each stage until the arrival of each stage; (ii) take narcotic substances and/or substances capable of altering psycho-physical conditions.

Any modification and/or concealment, even if only partial, of the number plate of a competing car and/or of an accompanying assistance car will be immediately reported to the public authorities. Any modification and/or concealment, even if only partial, of the number plate of a competing car will also result in its immediate exclusion from the event. The modification and/or concealment, even if only partial, of the number plate of an assistance car will result in the exclusion of the competitor from the event.

9.9 CHECKING OF PERSONAL IDENTIFICATION DEVICE (CPI)

For the entire duration of the event, the Officials on duty can ask the drivers to see their CPI. Drivers that cannot show their stickers could be expelled from the race by the Stewards.

10. RUNNING OF THE RACE

10.1 START

The cars will leave one at a time, from a stationary position with the engine running, 3 (three) cars departing every minute. Each car, once they have been given the "go", will have to free the Departure area as quickly as possible.

Under the control of Officials, departure may take place by pushing the car, if it fails to leave on its own.

Competitors must not stop the race car in the control areas (between the areas signalling the Start and End areas), exception being made for the check areas where the authorisation stamp will be printed by the Officials, reversing, changing direction, opening doors and in any way hindering the other teams will lead to the application of the penalty as stated in Article 12 of these SR.

The teams that do not make the CO/TC 1 Brescia - Departure Leg 1, will be penalized as specified in Article 12 of these SR for each missed transit check. Transit at CO/TC of the Leg 2 - Departure will still be mandatory, under penalty of exclusion.

Drivers must keep to the Official Times stated in the Itinerary Table. No restrictions will be imposed on them as regards the use of time recording equipment. The same may be synchronized with the clock placed at the start of each Leg, without direct connection to the said clock.

Any defect in detection of times, caused by any failure or malfunction of the equipment, will result, for the said checks, in the application of the average to each competitor and/or the annulment of the checks themselves for all competitors.

The organisers will state in the Road book, this will also be indicated on site, a straight stretch of road with measurements, used as the measured base in the preparation of the Road book, and competitors can verify this before the race.

10.2 TIME CONTROLS (CO/TC)

The purpose of the Time Control (CO/TC) is to outline the areas in which the route of the race is divided, in order to regulate the conduct of the same and to make sure the average speed is respected.

Each competitor (even when 3 cars a minute have been planned for) must be measured on the minute (e.g. for transit time 14:01 it will be possible to transit without penalty from 14:01:00 to 14:01:59).

The excesses as regards the ideal times established will determine the classification. Penalties for delays and early arrivals at a CO/TC are those stated in Article 12.1 of these SR.

Delays and early arrivals at a CO/TC must not be caught up in the next CO/TC. Teams must leave the "check area" free for transit. They are authorised to enter this area on board their car, in the minute preceding the ideal one for transit, and remain in the area for the time strictly necessary to record the transit time.

When the time is being read, the car must be inside the time reading area. During reading operations, at least one member of the team must be on board the race car.

The time used for the reading operation is not neutralised in any way. The reading is taken at the moment in which one member of the team hands over the Time Card to the Time-keeper.

If the race cars that are late or in advance of their ideal times transit through the CO/TC in the minute pertaining to cars on time, the Time-keeper will make a note, on the Time Card of the team that is late or in advance, of the real transit time, which corresponds to the start of the next sector, giving precedence, in the marking operations, to the team with the less delay on the ideal transit time.

All the CO/TCs will be appropriately marked with signs in compliance with the examples attached to these SR (Appendix 5).

Vehicles transiting through an OC/TC in the opposite direction or a direction other than the one decided by the organiser will be excluded from the race.

10.3 TIME TRIALS (PC/TT)

Time Trials (PC/TT) are those timed areas of the route, between two consecutive readings where the drivers must keep to a set time indicated in the Itinerary Table and in the Time Card.

Readings will be done at 1/100th of a second without any tolerance. Differences in the ideal time will, as for the differences read at CO/TC, be used in determining the classification.

PC/TT will be undertaken with departure read at free entrance; the driver will be able to choose freely the start of the PC, nonetheless within approx. 5 seconds from the "all clear" given by the Marshals and/or the Timekeeper in charge.

Various consecutive PC/TTs will be envisaged (interconnected), where the time for passing to the final reading of the previous PC/TT will be the start time of the next PC/TT, and so forth.

For PC/TT located in equipped areas or temporary circuits, racetracks, kart-racing tracks, and for PC/TTs with lengths less than 300m, an appropriate map will be attached with the Road Book.

All PC/TTs will be properly marked both at the start and at the end, with signs in compliance with the examples attached to these SR (Appendix 5).

In the area of the route between the yellow sign and the beige sign showing the start and end of the measuring area, cars are not allowed to park, stop or open the doors. Should any cars stop in this measuring area due to a breakdown, they must be immediately removed according to the instructions given by the race official, on penalty of exclusion. Furthermore, unauthorised access by drivers and navigators is also forbidden.

Vehicles transiting through a PC/TC area in the opposite direction than the one decided by the organiser will be excluded from the race.

In the case of a lack or defect in the detection of one or more transits made by a Competitor in one or more PC/TTs, the Competitor will always be assigned a time relating to the missing PC/TT(s). The time assigned will be the result of the average of the PC/TTs actually played by the Competitor in the Leg in which the PC/TT(s) are missing or incorrectly recorded; the application will be made at the end of the Stage considered.

10.4 AVERAGE TRIALS (PM/AT)

Average Trials (PM/AT) are those sections of the route in a sector in which drivers must maintain a pre-established hourly average, indicated in the TDT and the Time Card.

For the purposes of the Trial classification, all the scores made by proceeding to the arithmetic sum of the scores taken from the "TABLE OF POINTS FOR THE AVERAGE TRIALS" attached to the Supplementary Regulations of the race will be considered; the total of the points will then be divided by the number of scores made in the Trial considered.

The Road book will indicate the starting place and the place that constitutes the theoretical maximum limit of the PM/AT end. In the sector between the beginning and the end of the PM/AT, the average is measured at one or more points not known by the driver: the TDT will indicate the number of measurements made

for each PM/AT. For each average trial it will be possible to foresee up to 5 measurements.

The transit time will be recorded per second, rounded down, through the GPS-Tracker equipment installed at the pre-race checks. No objection is permitted against this finding.

10.4.1 START OF AVERAGE TRIALS

a. The PM/AT start will be "free start". Each PM/AT start will consist of two positions provided in the RB, located between 40 and 100 metres apart.

The first station, manned by Marshals whose task is to facilitate and regulate the departures of the cars, will be indicated by a yellow background sign, with a waving flag. The Marshals in charge will not record the time of passage of the cars on the Competitors' Time Card.

The second station, created to allow the best precision of the timing function of the GPS-tracking equipment by detecting the transit of the car already in motion, will not be manned by Marshals and will be indicated by a red background sign with a waving flag.

b. The competitor, once he has received an "all clear" signal from the marshals at the first station must proceed immediately, without stopping, to the second station and take the actual start for the PM/AT from the **Zero space/Zero time** line corresponding to that station. At this line, the competitor must start counting space and time in order to respect the imposed average assigned for each Trial.

c. In order to allow the competitor to reach the ideal average, there will be no measurements during the first kilometre of each Trial.

d. No complaints will be accepted regarding any obstacles, difficulties or hindrances that may arise in the course of the PM/AT: each competitor must overcome them using his or her own means and abilities, while respecting the Road Traffic Regulations.

10.5 PASSAGE CONTROLS (CT/PC)

The purpose of the Passage Controls (CT/PC) is to check the strict adherence to the established route.

The opening and closing times of the CT/PC will be notified by the Clerk of the course Bulletin. At the CT/PCs, drivers must stop the cars in order for the check stamp or "all clear" stamp to be printed in the relative area of the Time Card. The absence of this stamp will mean exclusion.

All the CT/PC areas will be properly marked with signs in compliance with the examples attached to these SR (Appendix 6).

Vehicles transiting through a CT/PC area in the opposite direction or one other than the one decided by the Organiser will be excluded from the race.

10.6 ARRIVAL

Arrival check will be in Brescia – TBD and will be open from __TBA__ on Saturday 13st June 2026.

After the arrival CO/TC, competitors will proceed following the instructions given by Marshals, to the arrival ramp.

11. MAXIMUM LATENESS

A crew will be over the maximum lateness:

- a) if it transits through a Time Control (CO/TC) with more than 30 minutes delay.
- b) if it accumulates delays through various Time Controls totalling more than 60 minutes delay for each leg.

Only at the starting CO/TC of each Leg will a crew be considered over the maximum time limit if they transit with more than 15 minutes of delay.

The opening and closing times of the Time Trials (PC/TT), the Average Trials (PM / AT) and of the Print Checks (CT/CP) will be notified through a Clerk of the course Bulletin.

12. PENALTIES AND DISCIPLINARY MEASURES

12.1 TIME CHECKS (CO/TC)

- | | |
|--|-----------------------------|
| • for every minute or fraction thereof early: | 100 negative penalty points |
| • for the first 2 minutes or fraction thereof late: | 25 negative penalty points |
| • For more than 2 minutes and up to 5 minutes: | 50 negative penalty points |
| • For delay of more than 5 minutes and up to 10 minutes: | 100 negative penalty points |

	<ul style="list-style-type: none"> • Over 10 minutes and up to 20 minutes: • For over 20 and up to 30 minutes: • For each delay beyond the maximum time: 	<p>200 negative penalty points 300 negative penalty points 12,000 negative penalty points</p>
12.2	TIME TRIALS (PC/TT)	
	<ul style="list-style-type: none"> • for each 1/100 of second early or late: 	1 negative penalty point
12.3	SECRET TRANSIT CHECKS	
	<ul style="list-style-type: none"> • up to 20 minutes early: • more than 20 minutes early: • 2nd time more than 20 minutes early: 	<p>320 negative penalty points 12,000 negative penalty points exclusion</p>
12.4	TIME CARD	
	<ul style="list-style-type: none"> • alterations, changes or corrections not endorsed by Officials: • Failure to record a CO/TC: • Lack of a control stamp (CT/PC): • Failure to return to the CO/TC of Leg arrival: 	<p>exclusion 12.000 negative penalty points 12.000 negative penalty points exclusion</p>
12.5	OTHER PENALTIES	
	<ul style="list-style-type: none"> • refusal to start at the hour and in the set order: • stopping the car in the control area (stationary wheel): • unauthorised access of the crew in the check area (subject to further action): • missing transit or time annotation at any control point: • unauthorized stopping in a control area: • blocking the passage and/or damaging other crews: • for non-sportsmanlike behaviour • for passage in a control area in a wrong or different direction: • for infringements of the Road Safety Rules: • document irregularities during administrative checks: • failure to comply with the checking times: • not starting at the first and the second Legs: • allowing a person other than a crew member to drive the car: • lack of a race number or race license plate: • lack of two or all of the race numbers: • failure to comply with provisions concerning the synchronization of chronometers: • for non-prudent behaviour of a crew member, or assistants or team car: • for leaning out of a moving car: • Failure to comply with the orders of Officials and Marshals: • Article 8.6 - first offense: • Article 8.6 - second offense: • infringements of the rules on advertising on cars in the race: 	<p>100 negative penalty points 100 negative penalty points</p> <p>300 negative penalty points 12.000 negative penalty points 12.000 negative penalty points exclusion from warning to exclusion exclusion up to exclusion non-acceptance up to non-acceptance exclusion exclusion fine exclusion</p> <p>up to exclusion</p> <p>up to exclusion up to exclusion up to exclusion 1.000 negative penalty points 12.000 negative penalty points 12.000 negative penalty points</p>

13. CLASSIFICATION-PROTESTS AND APPEALS

13.1 CLASSIFICATION

The following classifications will be drawn up:

- a) overall classification;
- b) group classification;
- c) special classification:
 - c1) under 30 crews;
 - c2) by crews and cars registered by the Armed Forces;
 - c3) "Sponsor Team" compiled by adding the individual scores of the Overall Classification obtained from the best 3 crews belonging to each Sponsor Team;
 - c4) "Guest Car".

13.2 COMPILATION AND PUBLICATION OF RESULTS

Classifications will be drafted on the basis of points scored by each crew in the PC/TT, in the PM/AT, the CO/TC and calculated according to the "points table" (Appendixes 7 and 8) and the coefficient assigned to each car (Appendix 6), deducting any possible negative penalty points.

"Differences" are not provided for.

The crew that receives the highest number of points will be declared the winner.

In case of a tie in the final classification, the winning position will be awarded to the crew/crews that has/have accumulated the least number of penalties, not points, during the race.

Those crews that do not transit or do not hand in the Time Card to the final arrival point, (the arrival of Leg 4), will not be classified.

The results will be published as per the Programme.

13.3 PROTESTS AND APPEALS

Protests and appeals must be submitted in the manner and within the terms established by the National Sporting Regulations.

- For each protest, the security deposit is € 500,00.
- For each appeal, the security deposit is € 2.000,00.

13.4 TERMS FOR SUBMISSION OF PROTESTS OR REQUESTS OF TIME CHECK

The classifications compiled at the end of Legs 1, 2, 3 and 4 are to be considered final in the elements used to complete them. These classifications will be published 30 minutes before the start of each Leg: competitors may submit a complaint (including a request of timing verification) against published documents, until the time of their individual starts by presenting a document with reasons for the dispute to the Competitor Relations Officers present at the start.

14. PRIZES

The event will have the following honour prizes:

- for the first 3 crews of the overall classification (prizes for both crew members);
- for the first 3 classified of the group classification (prizes for both crew members);
- for the first 3 classified of the under 30 classification (c1 classification): (prizes for both crew members);
- for the first place in other special classifications:
 - Armed Forces (classification c2): prizes for both crew members;
 - Sponsor Team (classification c3): a single prize, for first place;
 - Guest Car (classification c4): a single prize, for first place.

Prizes are not cumulative, therefore the winners of more than one classification will be awarded to prize for the most important classification.

Crews that are not present at the prize giving will forfeit their prizes without the classification being changed.

15. GENERAL RULES

15.1 RESPONSIBILITIES

By the very act of entering for this event, each competitor declares for themselves and their drivers, for the staff on their own service vehicles and accompanying vehicles, for their dependents and assignees:

- to recognize and accept the provisions of the National Sporting Regulations (and Sector Rules) and the present SR, committing themselves to respect and to enforce them;
- under their direct responsibility, to have their Drivers, their assistance personnel, employees and appointees sign these SRR for acceptance, which shall be strictly observed;
- to relieve the Italian Automobile Club, the ACI Sport, the ACI Brescia, the Organiser 1000 Miglia S.r.l. and all persons involved in the organisation, as well as the Automobile Clubs involved in the event, the Local Authorities involved, the Officials and the owners of the routes where the race takes place from any liability regarding any damages to competitors, or their drivers, navigators, employees and agents, or things, or produced or caused to third parties or of objects by the competitor himself, his drivers, navigators, employees and agents.

15.2 DISPUTES

Competitors undertake to resolve any dispute of a patrimonial nature that may arise due to facts arising from the application and/or interpretation of these SRR and from the course of the Event by means of the sports arbitration provided for in articles 236 et seq. of the National Sporting Regulations and the ACI Sporting Justice Regulations for disputes of a sporting nature that occurred during the Event. All disputes of a technical and disciplinary nature definitively decided by the Organiser and/or its own bodies that have given rise to penalisation or exclusion from the Event rankings or to financial penalties are expressly excluded from the sporting arbitration;

15.3 ADVERTISING

No form of advertisement may be placed on the car, unless this is expressly provided for by the organiser, which will be announced by a special information bulletin, in compliance with the provisions of current ACI Sport legislation.

Competitors whose cars were entered by the Sponsor in the "Sponsor Team", can exhibit on the sides of their cars, a logo or wording having maximum dimensions of 10 x 20 cm or similar.

The accepted logo or wording can echo the commercial Trademark of the sponsor and can appear on race cars belonging to each mentioned "Sponsor Team" and will in any case be subject to prior authorisation by the Organiser.

The number of authorised race cars for each Sponsor, will be determined by the agreements signed between the Organiser and the Sponsor itself.

To obtain the Organiser's authorisation, each interested Sponsor must submit the planned artwork and state which motor cars will be part of his "Sponsor Team" sending his request within and no later than 15th May 2026, to the following address: participants@1000miglia.it

The names of the crewmembers can be written on each of the sides of the race cars in the maximum dimension of 10 x 40 cm per side.

A Club logo, not having advertising purpose (all or part thereof), can appear on each side of race cars occupying a maximum space of 10 x 10 cm, per side or equivalent surface.

The original livery is tolerated as regards identification badges, even if they constitute advertising, limited however to what was originally used for that specific vehicle identified with the chassis number.

Any form of advertising that does not correspond to what is stated in this article will be removed by the Organiser and/or by Officials who will carry out checks before and during the race.

The breach of the provisions of this article will be sanctioned with 12,000 negative penalty points. Those crews that will be found non-compliant with the provisions set forth above will be denied participation in future editions of the event. The organiser reserves the right to charge the offending crew with damages resulting from the contravention of this Article.

The participants therefore agree to assume the obligation to pay compensation for all damages suffered by the organiser and third parties in general, relieving the same from any liability, for any and all liability and/or damages resulting from the violation of the abovementioned prohibition.

15.4 RACE NUMBER PLATES

All the race numbers (plates) handed over by the Organiser to the competitor must be attached to the race cars. The discovery of one of the delivered race number plates on a car other than the race car, will lead to a penalty that could result in the immediate exclusion of the same race car from the race.

15.5 OTHER PLATES PROVIDED BY THE ORGANIZER

All cars with race number plates of the 1000 MIGLIA 2025 event applied, bearing the wording of function:

- Race number 500
- Race number 1000
- ORGANIZATION
- MEDIA
- MEDIA PARTNER
- SPONSOR and SPONSOR GUEST
- FRIENDS
- CHARITY
- GUEST CAR
- MEDICAL CAR

being part of the race convoy and also authorized to transit on roads temporarily closed to ordinary traffic are cars and crews not in the race and always travel under the responsibility of their owners and drivers.

16. COMPULSORY MOTOR VEHICLE LIABILITY INSURANCE (MVL) AND THIRD PARTY LIABILITY INSURANCE (TPL)

Following the announcement made by ACI-Sport on 6 May 2025 regarding the awarding of the contract for compulsory insurance cover pursuant to Article 124 of the Private Insurance Code, the Organiser declares

that it has taken note that the procedure has been awarded to Sara Assicurazioni S.p.A., which has guaranteed insurance coverage for all races included in the national sporting calendar from 12 May 2025 to 31 December 2025. Pending the new decision by ACI-Sport for the races included in the 2026 national sporting calendar, the Organiser 1000 MIGLIA SRL declares that it will guarantee the compulsory insurance coverage for the race in question, in compliance with the provisions of the Federation.

It is hereby specified that the Third-Party Liability insurance policy taken out by the Organiser shall be understood as a policy covering second risk liability for any damage caused by competitors to persons, property or animals during the event, excluding damage caused to the participants themselves and to the vehicles they use. All competitors therefore remain obliged to take out their own Third-Party Liability insurance policy valid for the entire duration of the event.

In any case, the policies taken out by the Organiser do not relieve Competitors and Drivers of any liability they may incur outside the scope of the insurance and any additional general and special policy conditions that may be established by the Federation.

17. APPENDIXES

The following appendixes are an integral part of these SR:

- **APPENDIX 1:** Fac-simile of the Medical Certificate for non-competitive sports activities;
- **APPENDIX 2:** Positioning of race numbers on the cars;
- **APPENDIX 3:** Itinerary Table: (the definitive Itinerary Table will be communicated with the Road book);
- **APPENDIX 4:** Maps of the route: (the definitive maps will be communicated with the Road book);
- **APPENDIX 5:** Signage Posters of Checks;
- **APPENDIX 6:** Coefficients Table;
- **APPENDIX 7:** Points table for the Time Trial (TT);
- **APPENDIX 8:** Points table for the Average Tests (AT).

Supplementary Regulations for the "Grande Evento" for historic cars to be held on 7 to 13 June 2026 called *1000 MIGLIA 2026*.

The organizer declares the commitment to verify that all those who will participate in the competition, but are not included in this SRR, will be holders of a valid sports license issued by the Federation.

The carrying out of the tender is in any case subject to the release of the authorization by the Italian Ministry of Transport, as provided for by the art. 9, paragraph 3, Italian Street Code.

This SRR and the related permission to organize may be revoked at any time in the event of violation by the Organizer of the art. 56 of the RNS.

The Clerk of the course
(has read and accepts the appointment)

signed: Mr. *Lucio DE MORI*

The legal representative of the Organising Body

signed: Mr. *Fulvio D'ALVIA*

For the Regional Delegation

signed: Mr. *Alessandro TIBILETTI*

SEEN AND APPROVED
THE SECRETARY OF ACI SPORTS BODIES
signed: Mr. *Marco FERRARI*

Attachment 1: Fac-simile Medical Certificate for non-competitive Sporting Activities

Certificato di idoneità alla pratica di attività sportiva di tipo non agonistico
Certificat d'aptitude à la pratique d'un sport non professionnel
Medical certificate for non-competitive sport activity

Sig. - Sig.ra \ Mons. - Mme\ Mr. - Mrs: _____

nato - nata a \ né à \ born in: _____

il \ le \ on: _____

indirizzo \ adresse \ address: _____

Il soggetto, sulla base della visita medica da me effettuata, dei valori pressione arteriosa rilevati, nonché dal referto del tracciato ECG eseguito in data _____

non presenta controindicazioni in atto alla pratica di attività sportiva non agonistica.

(Decreto del Ministro della Salute del 24 aprile 2013; Legge del 9 agosto 2013, n. 98, art. 42-*bis*; Legge 30 ottobre 2013, n. 125, art. 10 - *septies*; Decreto del Ministero della Salute dell'8 agosto 2014)

Based on a physical examination, including blood pressure readings, and from the results of the ECG test, carried out on _____

I hereby declare my client is in good health and fit to practice non-competitive sport activities

Sur la base d'un examen médical réalisé par mes soins, des valeurs de la pression artérielle relevées ainsi que du résultat du test ECG effectué le _____

le patient ne présente pas de contre-indication à la pratique d'activités sportives non professionnels.

Il presente certificato ha validità annuale dalla data del rilascio

Ce certificat est valable 1 an

This certificate is valid for a period of one year

Luogo | Lieu | Issued in: _____ il | le | on: _____

Il Medico \ le Medecin \ the Doctor (*firma e timbro - signature et tampon - signature and stamp*):

Attachment 2: Posting of Race Numbers on the cars

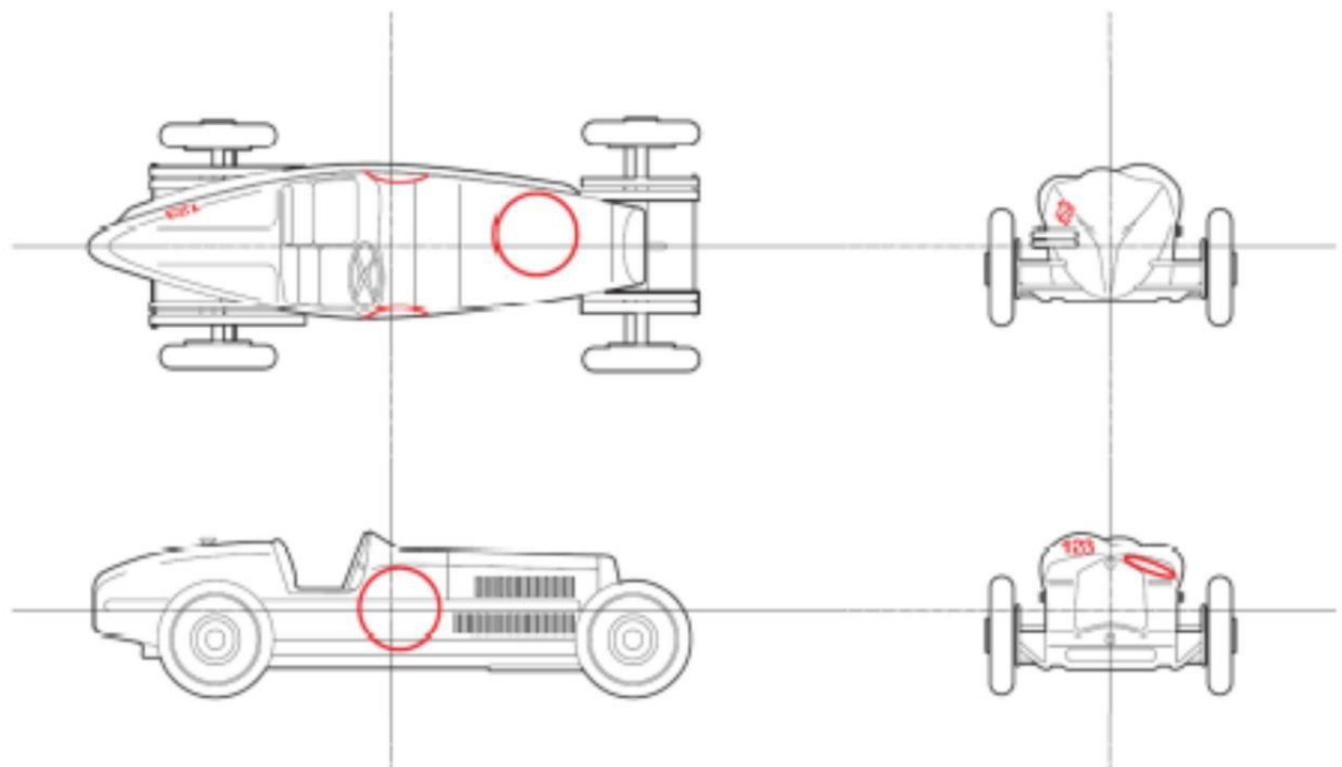
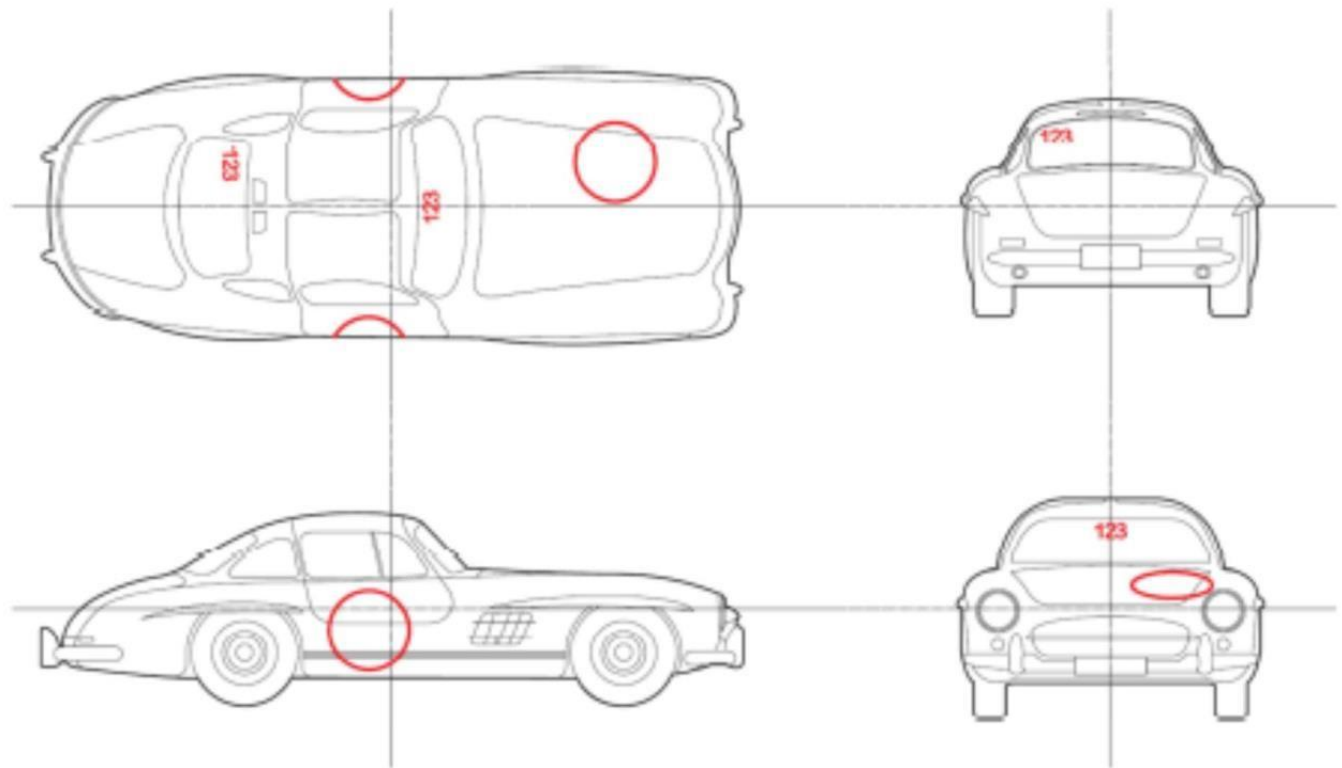

Attachment 3: Itinerary, Times and Distance Table

The TDT will be distributed together with the Road book.

Attachment 4: Maps of the route



9-13
GIUGNO
/ JUNE
➔➔



DISCOVER MORE
1000miglia.it























1000 MIGLIA SRL



Attachment 5: Control Signs

CARTELLI DEI CONTROLLI - CONTROL SIGNS

CO / TC *	INIZIO ZONA CONTROLLO • CONTROL AREA START  GIALLO/YELLOW mt 25 circa - approx.	CONTROLLO • CONTROL  ROSSO/RED mt 25 circa - approx.	FINE ZONA CONTROLLO • CONTROL AREA END  BEIGE mt 25 circa - approx.	INIZIO ZONA CONTROLLO • CONTROL AREA START  GIALLO/YELLOW mt 25 circa - approx.	CONTROLLO • CONTROL  ROSSO/RED mt 25 circa - approx.	FINE ZONA CONTROLLO • CONTROL AREA END  BEIGE mt 25 circa - approx.
	CT / PC **					
PC*** SINGOLE O CONCATENATE LUNGHEZZA INFERIORE / UGUALE A 300 MT.	INIZIO ZONA CONTROLLO • CONTROL AREA START  GIALLO/YELLOW	CONTROLLO • CONTROL  ROSSO/RED	INIZIO ZONA CONTROLLO • CONTROL AREA START  BEIGE	INIZIO ZONA CONTROLLO • CONTROL AREA START  GIALLO/YELLOW	CONTROLLO • CONTROL  ROSSO/RED	INIZIO ZONA CONTROLLO • CONTROL AREA START  BEIGE
	TT**** SINGLE OR CONNECTED LENGTH INFERIOR / EQUAL TO 300 MT.					
PC*** SINGOLE O CONCATENATE LUNGHEZZA SUPERIORE A 300 MT.	INIZIO ZONA CONTROLLO • CONTROL AREA START  GIALLO/YELLOW	CONTROLLO • CONTROL  ROSSO/RED	INIZIO ZONA CONTROLLO • CONTROL AREA START  BEIGE	INIZIO ZONA CONTROLLO • CONTROL AREA START  GIALLO/YELLOW	CONTROLLO • CONTROL  ROSSO/RED	INIZIO ZONA CONTROLLO • CONTROL AREA START  BEIGE
	TT**** SINGLE OR CONNECTED LENGTH SUPERIOR TO 300 MT.					
PM PROVA DI MEDIA CON UNO O PIU' CONTROLLI SEGRETI	INIZIO ZONA CONTROLLO • CONTROL AREA START  GIALLO/YELLOW	CONTROLLO • CONTROL  ROSSO/RED	LIMITE DELL'ESTENSIONE DELLA PM - LIMIT AT EXTENTION			
	AT AVERAGE TEST WITH ONE OR MORE SECRET CONTROLS					

***Ai Controlli Orari NON SEGUITI da Start Prova Cronometrata**

Le vetture sono autorizzate ad entrare nella zona di controllo (tra il cartello giallo e quello rosso di controllo) nel minuto che precede il loro minuto teorico di transito (solo se la zona è già stata liberata dalle vetture che precedono) oppure nel loro minuto teorico di transito e devono consegnare la tabella di marcia al cronometrista, per l'annotazione dell'orario di transito. I membri dell'equipaggio sono autorizzati a rimanere a bordo della vettura.

****Ai Controlli Timbro**

I membri dell'equipaggio devono rimanere a bordo della vettura e consegnare al commissario la tabella di marcia, per l'apposizione del timbro, senza iscrizione dell'orario di transito; la sosta nella zona deve essere limitata all'operazione di timbratura.

*****Nelle Prove Cronometrate**

Tra il cartello giallo di inizio ed il cartello beige di fine zona controllo è vietato l'arresto (fermo vettura/fermo ruote) e la sosta della vettura.

***At the Time Controls NOT FOLLOWED by Start Time Trials**

The cars are authorized to enter the control area (between the yellow and red control sign) in the minute preceding their theoretical transit minute (only if the area has already been freed from the cars ahead) or during their theoretical transit minute and must hand in the time card to the timekeeper, in order for him to note down the transit time. Crew members are allowed to remain on board the car.

****During the Time Trials**

Between the yellow sign at the beginning and the beige sign at the end of the control area, it is forbidden to stop (vehicle stopped/wheels stopped) and park the car.

*****At the Stamp Controls**

The crew members must remain on board the car and hand in the time card to the Marshal, where he will put the stamp, without inscription of the transit time; parking in the area must be limited only to the stamping operation.

Attachment 6: Coefficients table



➔ In **ROSSO** sono riportate le vetture che hanno vinto un'edizione della 1000 Miglia dal 1927 al 1957.

RED shows cars that have won an edition of the Mille Miglia from 1927 to 1957.

➔ **WOA** - Winner Overall: tutte le vincitrici assolute hanno coefficiente 1,80. *All the overall race winners have a coefficient of 1.80.*

➔ Vincitrici di Classe / *Class Winner*: alle vetture vincitrici di Classe o Categoria in una edizione delle 1000 Miglia 1927/1957 viene aggiunto al coefficiente il "Fattore MM", pari a + **0,05**.

The "MM Factor", equal to + **0.05**, is added to the winning cars of Class or Category in an edition of the 1000 Miglia 1927/1957.

➔ In **AZZURRO** sono riportati i nuovi inserimenti. *The new entries are shown in BLUE.*

	MARCA MARQUE	MODELLO MODEL	COEFF. Multiplier	CALCULATION FACTOR						WINNER FACTOR
				PERIOD	CLASS	CAT.	PERIOD	CLASS	CAT.	
1	A.L.F.	Ardea 750 barchetta	1,35	1950-1952	<750	S	0,15	0	0,20	0
2	A.L.F.	Ardea 750 siluro	1,35	1950-1952	<750	S	0,15	0	0,20	0
3	A.L.F.	Ardea 750 spider	1,40	1947-1949	<750	S	0,20	0	0,20	0
4	A.L.F.	S.I.A.T.A. TC motore Ardea 750	1,30	1953-1957	<750	S	0,10	0	0,20	0
5	A.S.G.	SVA - Giannini 750	1,35	1950-1952	<750	S	0,15	0	0,20	0
6	ABARTH	600 FIAT	1,10	1953-1957	<750	T	0,10	0	0	0
7	ABARTH	750 Vignale	1,20	1953-1957	<750	GT	0,10	0	0,10	0
8	ABARTH	Cisitalia 204	1,65	1947-1949	<1100	SC	0,20	0,10	0,35	0
9	ABARTH	Cisitalia 204 A	1,60	1950-1952	<1100	SC	0,15	0,10	0,35	0
10	ABARTH	Cisitalia 204 A siluro	1,65	1947-1949	<1100	SC	0,20	0,10	0,35	0
11	ABARTH	Cisitalia 204 A spider	1,60	1950-1952	<1100	SC	0,15	0,10	0,35	0
12	ABARTH	Cisitalia 205 berlina Vignale	1,60	1950-1952	<1100	SC	0,15	0,10	0,35	0
13	ABARTH	FIAT 1100 S	1,60	1950-1952	<1100	SC	0,15	0,10	0,35	0
14	ABARTH	FIAT 1400 berlina Touring	1,40	1950-1952	>1101	GT	0,15	0,15	0,10	0
15	ABARTH	FIAT 750 Berlina	1,25	1953-1957	<750	GT	0,10	0	0,10	0,05
16	ABARTH	FIAT 750 Berlina Zagato	1,25	1953-1957	<750	GT	0,10	0	0,10	0,05
17	A.C.	Ace	1,40	1953-1957	>1101	SP	0,10	0,15	0,15	0
18	A.C.	Aceca Bristol Coupé	1,35	1953-1957	>1101	GT	0,10	0,15	0,10	0
19	ALA D'ORO	Stanguellini FIAT 1100 spider	1,50	1947-1949	<1100	S	0,20	0,10	0,20	0
20	ALCA	Volpe 124 cm3	1,40	1947-1949	<750	S	0,20	0	0,20	0
21	ALFA ROMEO	RL SS torpedo Zagato	1,70	1927-1929	>1101	S	0,35	0,15	0,20	0
22	ALFA ROMEO	RL SS torpedo	1,70	1927-1929	>1101	S	0,35	0,15	0,20	0
23	ALFA ROMEO	6C 1500	1,45	1930-1934	>1101	T	0,30	0,15	0	0
24	ALFA ROMEO	6C 1500 S	1,70	1927-1929	>1101	S	0,35	0,15	0,20	0
25	ALFA ROMEO	6C 1500 Sport Spider Zagato (winner 1928)	1,80	1927-1929	>1101	SS	0,35	0,15	0,25	WOA
26	ALFA ROMEO	6C 1500 SS	1,80	1927-1929	>1101	SS	0,35	0,15	0,25	0,05
27	ALFA ROMEO	6C 1500 MMS	1,80	1927-1929	>1101	SS	0,35	0,15	0,25	0,05
28	ALFA ROMEO	6C 1500 SS siluro Ghia	1,75	1927-1929	>1101	SS	0,35	0,15	0,25	0
29	ALFA ROMEO	6C 1500 SS	1,75	1930-1934	>1101	SS	0,30	0,15	0,25	0,05
30	ALFA ROMEO	6C 1500 SS spider Brianza	1,70	1930-1934	>1101	SS	0,30	0,15	0,25	0
31	ALFA ROMEO	6C 1500 SS spider Campari & Sorniotti	1,70	1930-1934	>1101	SS	0,30	0,15	0,25	0
32	ALFA ROMEO	6C 1500 SS spider Carr. Sport	1,70	1930-1934	>1101	SS	0,30	0,15	0,25	0

	MARCA MARQUE	MODELLO MODEL	COEFF. Multiplier	CALCULATION FACTOR						WINNER FACTOR
				PERIOD	CLASS	CAT.	PERIOD	CLASS	CAT.	
33	ALFA ROMEO	6C 1500 SS spider Ghia	1,70	1930-1934	>1101	SS	0,30	0,15	0,25	0
34	ALFA ROMEO	6C 1500 Gran Sport	1,75	1930-1934	>1101	SS	0,30	0,15	0,25	0,05
35	ALFA ROMEO	6C 1750 SS Spider Zagato (winner 1929)	1,80	1927-1929	>1101	SS	0,35	0,15	0,25	WOA
36	ALFA ROMEO	6C 1750 SS	1,75	1927-1929	>1101	SS	0,35	0,15	0,25	
37	ALFA ROMEO	6C 1750 GS Spider Zagato (winner 1930)	1,80	1930-1934	>1101	SS	0,30	0,15	0,25	WOA
38	ALFA ROMEO	6C 1750	1,45	1930-1934	>1101	T	0,30	0,15	0	0
39	ALFA ROMEO	6C 1750 GS	1,70	1930-1934	>1101	SS	0,30	0,15	0,25	0
40	ALFA ROMEO	6C 1750 GS a gasogeno	1,65	1930-1934	>1101	S	0,30	0,15	0,20	0
41	ALFA ROMEO	6C 1750 GT	1,60	1930-1934	>1101	GT	0,30	0,15	0,10	0,05
42	ALFA ROMEO	6C 1750 GT berlina Touring	1,55	1930-1934	>1101	GT	0,30	0,15	0,10	0
43	ALFA ROMEO	6C 1750 GT cabriolet Castagna	1,55	1930-1934	>1101	GT	0,30	0,15	0,10	0
44	ALFA ROMEO	6C 1750 S	1,60	1927-1929	>1101	GT	0,35	0,15	0,10	0
45	ALFA ROMEO	6C 1750 S torpedo	1,55	1930-1934	>1101	GT	0,30	0,15	0,10	0
46	ALFA ROMEO	6C 1750 S	1,60	1930-1934	>1101	GT	0,30	0,15	0,10	0,05
47	ALFA ROMEO	6C 1750 GS spider Brianza	1,70	1930-1934	>1101	SS	0,30	0,15	0,25	0
48	ALFA ROMEO	6C 1900	1,40	1935-1940	>1101	T	0,25	0,15	0	0
49	ALFA ROMEO	6C 2300	1,55	1935-1940	>1101	SP	0,25	0,15	0,15	0
50	ALFA ROMEO	6C 2300 B berlina	1,55	1935-1940	>1101	SP	0,25	0,15	0,15	0
51	ALFA ROMEO	6C 2300 B MM berlina Ghia	1,55	1935-1940	>1101	SP	0,25	0,15	0,15	0
52	ALFA ROMEO	6C 2300 B MM berlina Touring	1,60	1935-1940	>1101	SP	0,25	0,15	0,15	0,05
53	ALFA ROMEO	6C 2300 B motore 2500 SS	1,60	1935-1940	>1101	S	0,25	0,15	0,20	0
54	ALFA ROMEO	6C 2300 B MM spider Touring	1,65	1935-1940	>1101	S	0,25	0,15	0,20	0,05
55	ALFA ROMEO	6C 2300 GT berlina	1,50	1935-1940	>1101	GT	0,25	0,15	0,10	0
56	ALFA ROMEO	6C 2300 GT spider	1,50	1935-1940	>1101	GT	0,25	0,15	0,10	0
57	ALFA ROMEO	6C 2300 Pescara Touring	1,50	1935-1940	>1101	GT	0,25	0,15	0,10	0
58	ALFA ROMEO	6C 2300 Pescara berlina Touring	1,60	1935-1940	>1101	SP	0,25	0,15	0,15	0,05
59	ALFA ROMEO	6C 2300 Pescara spider	1,50	1935-1940	>1101	GT	0,25	0,15	0,10	0
60	ALFA ROMEO	6C 2300 Pescara spider Zagato	1,50	1935-1940	>1101	GT	0,25	0,15	0,10	0
61	ALFA ROMEO	6C 2300 Pescara Sport Spider Touring	1,60	1935-1940	>1101	S	0,25	0,15	0,20	0
62	ALFA ROMEO	6C 2500	1,60	1935-1940	>1101	S	0,25	0,15	0,20	0
63	ALFA ROMEO	6C 2500 SS spider Touring corsa	1,70	1935-1940	>1101	SS	0,25	0,15	0,25	0,05
64	ALFA ROMEO	6C 2500 SS spider corsa	1,65	1935-1940	>1101	SS	0,25	0,15	0,25	0
65	ALFA ROMEO	6C 2500 SS spider Albanesi	1,55	1947-1949	>1101	S	0,20	0,15	0,20	0
66	ALFA ROMEO	6C 2500 SS spider	1,55	1947-1949	>1101	S	0,20	0,15	0,20	0
67	ALFA ROMEO	6C 2500 SS spider Pinin Farina	1,55	1947-1949	>1101	S	0,20	0,15	0,20	0
68	ALFA ROMEO	6C 2500 SS Spider Colli	1,65	1947-1949	>1101	SS	0,20	0,15	0,25	0,05
69	ALFA ROMEO	6C 2500 SS coupé Touring	1,55	1947-1949	>1101	S	0,20	0,15	0,20	0
70	ALFA ROMEO	6C 2500 berlina	1,35	1947-1949	>1101	T	0,20	0,15	0	0
71	ALFA ROMEO	6C 2500 S cabriolet Pinin Farina	1,45	1947-1949	>1101	GT	0,20	0,15	0,10	0
72	ALFA ROMEO	6C 2500 SS "torpedino Brescia"	1,55	1947-1949	>1101	S	0,20	0,15	0,20	0
73	ALFA ROMEO	6C 2500 SS cabriolet Pinin Farina	1,55	1947-1949	>1101	S	0,20	0,15	0,20	0
74	ALFA ROMEO	6C 2500 Competizione	1,65	1947-1949	>1101	SS	0,20	0,15	0,25	0,05
75	ALFA ROMEO	6C 2500 Freccia Oro	1,40	1950-1952	>1101	T	0,20	0,15	0	0,05
76	ALFA ROMEO	6C 3000 C50 berlina Touring	1,65	1950-1952	>1101	SC	0,15	0,15	0,35	0
77	ALFA ROMEO	6C 2500 SS	1,55	1950-1952	>1101	S	0,15	0,15	0,20	0,05
78	ALFA ROMEO	6C 2500 S cabriolet Touring	1,40	1950-1952	>1101	GT	0,15	0,15	0,10	0
79	ALFA ROMEO	6C 3000 CM berlina Colli	1,60	1953-1957	>1101	SC	0,10	0,15	0,35	0
80	ALFA ROMEO	8C 2300 spider	1,70	1930-1934	>1101	SS	0,30	0,15	0,25	0
81	ALFA ROMEO	8C 2300	1,70	1930-1934	>1101	SS	0,30	0,15	0,25	0
82	ALFA ROMEO	8C 2300 Spider Touring (winner 1932)	1,80	1930-1934	>1101	SS	0,30	0,15	0,25	WOA

	MARCA MARQUE	MODELLO MODEL	COEFF. Multiplier	CALCULATION FACTOR						WINNER FACTOR
				PERIOD	CLASS	CAT.	PERIOD	CLASS	CAT.	
83	ALFA ROMEO	8C 2300 MM Spider Zagato (winner 1933)	1,80	1930-1934	>1101	SS	0,30	0,15	0,25	WOA
84	ALFA ROMEO	8C 2300 Monza	1,70	1930-1934	>1101	SS	0,30	0,15	0,25	0
85	ALFA ROMEO	8C 2300 spider Castagna	1,70	1930-1934	>1101	SS	0,30	0,15	0,25	0
86	ALFA ROMEO	8C 2600 Monza (winner 1934)	1,80	1930-1934	>1101	SS	0,30	0,15	0,25	WOA
87	ALFA ROMEO	8C 2600 Monza spider Brianza	1,70	1930-1934	>1101	SS	0,30	0,15	0,25	0
88	ALFA ROMEO	Tipo B 2900 "P3" (winner 1935)	1,80	1935-1940	>1101	SS	0,25	0,15	0,25	WOA
89	ALFA ROMEO	B 2900	1,65	1935-1940	>1101	SS	0,25	0,15	0,25	0
90	ALFA ROMEO	8C 2900 A (winner 1936 - 1937)	1,80	1935-1940	>1101	SS	0,25	0,15	0,25	WOA
91	ALFA ROMEO	8C 2900 B MM (winner 1938)	1,80	1935-1940	>1101	SS	0,25	0,15	0,25	WOA
92	ALFA ROMEO	8C 2900 B [senza compressore] Berlinetta (winner 1947)	1,80	1935-1940	>1101	SS	0,25	0,15	0,25	WOA
93	ALFA ROMEO	8C 2900 B MM spider Touring	1,65	1935-1940	>1101	SS	0,25	0,15	0,25	0
94	ALFA ROMEO	1900 e 1900 TI	1,35	1950-1952	>1101	T	0,15	0,15	0	0,05
95	ALFA ROMEO	1900 Super e 1900 Super TI	1,30	1953-1957	>1101	T	0,10	0,15	0	0,05
96	ALFA ROMEO	1900 M "Matta"	1,35	1950-1952	>1101	T	0,15	0,15	0	0,05
97	ALFA ROMEO	1900 C Gara	1,45	1950-1952	>1101	SP	0,15	0,15	0,15	0
98	ALFA ROMEO	1900 Sprint	1,40	1950-1952	>1101	GT	0,15	0,15	0,10	0
99	ALFA ROMEO	1900 Super Sprint	1,35	1953-1957	>1101	GT	0,10	0,15	0,10	0
100	ALFA ROMEO	1900 SSZ [Zagato]	1,40	1953-1957	>1101	SP	0,10	0,15	0,15	0
101	ALFA ROMEO	412 spider Touring	1,65	1950-1952	>1101	SC	0,15	0,15	0,35	0
102	ALFA ROMEO	412 spider Vignale	1,65	1950-1952	>1101	SC	0,15	0,15	0,35	0
103	ALFA ROMEO	Giulietta Sprint Bertone	1,35	1953-1957	>1101	GT	0,10	0,15	0,10	0
104	ALFA ROMEO	Giulietta Sprint Veloce Bertone	1,40	1953-1957	>1101	GT	0,10	0,15	0,10	0,05
105	ALFA ROMEO	Giulietta "Sebring"	1,45	1953-1957	>1101	S	0,10	0,15	0,20	0
106	ALFA ROMEO	Giulietta GTZ (Zagato)	1,40	1953-1957	>1101	SP	0,10	0,15	0,15	0
107	ALFA ROMEO	Giulietta spider speciale monoposto	1,45	1953-1957	>1101	S	0,10	0,15	0,20	0
108	ALFA ROMEO	Giulietta spider "Sebring"	1,45	1953-1957	>1101	S	0,10	0,15	0,20	0
109	ALFA ROMEO	Giulietta berlina	1,30	1953-1957	>1101	T	0,10	0,15	0	0,05
110	ALLARD	J2 Cadillac	1,50	1950-1952	>1101	S	0,15	0,15	0,20	0
111	ALPINE-RENAULT	A 106 MM	1,30	1953-1957	<750	SP	0,10	0	0,15	0,05
112	AMILCAR	1100	1,60	1930-1934	<1100	S	0,30	0,10	0,20	0
113	AMILCAR	CGSs siluro corsa	1,70	1927-1929	<1100	SS	0,35	0,10	0,25	0
114	AMILCAR	CGSs spider	1,65	1927-1929	<1100	S	0,35	0,10	0,20	0
115	AMP (Alfa Maserati Prete)	6C 2500 Sport	1,70	1947-1949	>1101	SC	0,20	0,15	0,35	0
116	ANSALDO	Tipo 4H	1,70	1927-1929	>1101	S	0,35	0,15	0,20	0
117	ANSALDO	Tipo 6B	1,70	1927-1929	>1101	S	0,35	0,15	0,20	0
118	ANSALDO	Tipo 6B IV serie	1,70	1927-1929	>1101	S	0,35	0,15	0,20	0
119	ARNOLT	Bristol *	1,45	1953-1957	>1101	S	0,10	0,15	0,20	0
120	ASTON MARTIN	Le Mans	1,65	1930-1934	>1101	S	0,30	0,15	0,20	0
121	ASTON MARTIN	Ulster	1,70	1935-1940	>1101	SS	0,25	0,15	0,25	0,05
122	ASTON MARTIN	2 Litre Speed Model	1,60	1935-1940	>1101	S	0,25	0,15	0,20	0
123	ASTON MARTIN	2 Litre Speed Model "Spa Special"	1,50	1950-1952	>1101	S	0,15	0,15	0,20	0
124	ASTON MARTIN	DB 2	1,45	1950-1952	>1101	GT	0,15	0,15	0,10	0,05
125	ASTON MARTIN	DB 2/4	1,35	1953-1957	>1101	GT	0,10	0,15	0,10	0
126	ASTON MARTIN	DB 3	1,60	1953-1957	>1101	SC	0,10	0,15	0,35	0
127	ASTON MARTIN	DB 3S	1,60	1953-1957	>1101	SC	0,10	0,15	0,35	0
128	AUSTIN	Seven Sports	1,60	1930-1934	<750	S	0,30	0,10	0,20	0
129	AUSTIN HEALEY	100/4	1,35	1953-1957	>1101	GT	0,10	0,15	0,10	0
130	AUSTIN HEALEY	100/6	1,35	1953-1957	>1101	GT	0,10	0,15	0,10	0
131	AUSTIN HEALEY	100 M	1,35	1953-1957	>1101	GT	0,10	0,15	0,10	0

	MARCA MARQUE	MODELLO MODEL	COEFF. Multiplier	CALCULATION FACTOR						WINNER FACTOR
				PERIOD	CLASS	CAT.	PERIOD	CLASS	CAT.	
132	AUSTIN HEALEY	100 S	1,50	1953-1957	>1101	S	0,10	0,15	0,20	0,05
133	AUTO AVIO COSTRUZIONI	815 spider Touring	1,65	1935-1940	>1101	SS	0,25	0,15	0,25	0
134	AUTOBLEU	Type Mille Miglia	1,30	1953-1957	<750	SC	0,10	0	0,20	0
135	AVALLE	FIAT 750 Sport	1,60	1947-1949	<750	SC	0,20	0	0,35	0,05
136	AVALLE	S.I.A.T.A. 500 FIAT sport spider	1,55	1947-1949	<750	SC	0,20	0	0,35	0
137	AVALLE	S.I.A.T.A. 750 S	1,60	1947-1949	<750	SC	0,20	0	0,35	0,05
138	AVALLE	FIAT 750 barchetta	1,55	1947-1949	<750	SC	0,20	0	0,35	0
139	AVALLE	FIAT 750 spider	1,55	1947-1949	<750	SC	0,20	0	0,35	0
140	AVALLE	Moretti 750 siluro	1,50	1950-1952	<750	SC	0,15	0	0,35	0
141	AVALLE	FIAT 1100/103 berlina Accossato	1,55	1953-1957	<1100	SC	0,10	0,10	0,35	0
142	BAISTROCCHI	Balestrieri FIAT 1100 Sport	1,65	1947-1949	<1100	SC	0,20	0,10	0,35	0
143	BALESTRIERI	Baistrocchi FIAT 1100 Sport	1,55	1953-1957	<1100	SC	0,10	0,10	0,35	0
144	BANDINI	750 S	1,45	1953-1957	<750	SC	0,10	0	0,35	0
145	BANDINI	750 S Crosley	1,45	1953-1957	<750	SC	0,10	0	0,35	0
146	BANDINI	FIAT 1100 Sport	1,65	1947-1949	<1100	SC	0,20	0,10	0,35	0
147	BASSO-LANCIA	"Aurora" barchetta motore Aprilia	1,70	1947-1949	>1101	SC	0,20	0,15	0,35	0
148	BENEDETTI	Ermini 1100 siluro	1,60	1950-1952	<1100	SC	0,15	0,10	0,35	0
149	BENEDETTI	Ermini 1100 Sport	1,60	1950-1952	<1100	SC	0,15	0,10	0,35	0
150	BENEDETTI	FIAT 1100 Siluro	1,65	1947-1949	<1100	SC	0,20	0,10	0,35	0
151	BENEDETTI	FIAT 750 barchetta	1,55	1947-1949	<750	SC	0,20	0	0,35	0
152	BENEDETTI	Giannini 750 S	1,60	1947-1949	<750	SC	0,20	0	0,35	0,05
153	BENEDETTI	Giannini 750 Spider	1,50	1950-1952	<750	SC	0,15	0	0,35	0
154	BENEDETTI	Lancia Aurelia B20 berlina	1,40	1950-1952	>1101	GT	0,15	0,15	0,10	0
155	BENTLEY	3.5 Litre *	1,65	1930-1934	>1101	S	0,30	0,15	0,20	0
156	BENTLEY	4.5 Litre Supercharged*	1,70	1930-1934	>1101	SS	0,30	0,15	0,25	0
157	BIANCHI	20	1,70	1927-1929	>1101	S	0,35	0,15	0,20	0
158	BIANCHI	20 Sport	1,70	1927-1929	>1101	S	0,35	0,15	0,20	0
159	BIANCHI	20 Sport Torpedo	1,70	1927-1929	>1101	S	0,35	0,15	0,20	0
160	BIANCHI	20 Torpedo	1,70	1927-1929	>1101	S	0,35	0,15	0,20	0
161	BIANCHI	SS	1,65	1930-1934	>1101	SP	0,30	0,15	0,15	0,05
162	BIANCHI	SS 1300 spider	1,60	1930-1934	>1101	SP	0,30	0,15	0,15	0
163	BIANCHI	SS 1300 torpedo	1,60	1930-1934	>1101	SP	0,30	0,15	0,15	0
164	BIONDETTI	Jaguar - Ferrari Special [telaio Ferrari 166, motore XK 120]	1,65	1950-1952	>1101	SC	0,15	0,15	0,35	0
165	BIONDETTI	Jaguar C-Type Special [telaio Ferrari 166, motore XKC]	1,65	1950-1952	>1101	SC	0,15	0,15	0,35	0
166	B.M.W.	328	1,60	1935-1940	>1101	S	0,25	0,15	0,20	0
167	B.M.W.	328 berlina Kamm	1,65	1935-1940	>1101	SS	0,25	0,15	0,25	0
168	B.M.W.	328 Berlina Touring (winner 1940)	1,80	1935-1940	>1101	SS	0,25	0,15	0,25	WOA
169	B.M.W.	328 spider aerodinamico MM	1,65	1935-1940	>1101	SS	0,25	0,15	0,25	0
170	B.M.W.	328 spider speciale	1,60	1947-1949	>1101	SS	0,20	0,15	0,25	0
171	B.M.W.	328 speciale	1,50	1950-1952	>1101	S	0,15	0,15	0,20	0
172	B.M.W.	502	1,30	1953-1957	>1101	T	0,10	0,15	0	0,05
173	B.M.W.	507	1,35	1953-1957	>1101	GT	0,10	0,15	0,10	0
174	B.M.W.	750	1,35	1950-1952	<750	S	0,15	0	0,20	0
175	B.M.W.	750 telaio FIAT 500 siluro	1,40	1947-1949	<750	S	0,20	0	0,20	0
176	B.M.W.	750 telaio FIAT 500 spider	1,40	1947-1949	<750	S	0,20	0	0,20	0
177	B.N.C.	1100 sport biposto*	1,70	1927-1929	<1100	SS	0,35	0,10	0,25	0
178	BONOMI	Giannini 750 siluro Motto	1,45	1953-1957	<750	SC	0,10	0	0,35	0
179	BORGWARD	Isabella TS	1,25	1953-1957	>1101	T	0,10	0,15	0	0

	MARCA MARQUE	MODELLO MODEL	COEFF. Multiplier	CALCULATION FACTOR						WINNER FACTOR
				PERIOD	CLASS	CAT.	PERIOD	CLASS	CAT.	
180	BRANCA	FIAT 750 S	1,45	1953-1957	<750	SC	0,10	0	0,35	0
181	BRANCA	Moretti 1100 S	1,55	1953-1957	<1100	SC	0,10	0,10	0,35	0
182	BRANCA	Moretti 750 S	1,45	1953-1957	<750	SC	0,10	0	0,35	0
183	BRANCA	Moretti 750 Sport maggiorata 1100	1,55	1953-1957	<1100	SC	0,10	0,10	0,35	0
184	BRANCA	Testadoro - Moretti 750 S	1,45	1953-1957	<750	SC	0,10	0	0,35	0
185	BRISTOL	400	1,45	1947-1949	>1101	GT	0,20	0,15	10,00	0
186	BRIXIA (GEROSA)	Gil.Co S.I.A.T.A. 750 berlinetta	1,50	1950-1952	<750	SC	0,15	0	0,35	0
187	BUGATTI	GP 2 litri	1,70	1927-1929	>1101	S	0,35	0,15	0,20	0
188	BUGATTI	T 23 Brescia modifiée	1,70	1927-1929	>1101	S	0,35	0,15	0,20	0
189	BUGATTI	T 35	1,75	1927-1929	>1101	SS	0,35	0,15	0,25	0
190	BUGATTI	T 35 B	1,75	1927-1929	>1101	SS	0,35	0,15	0,25	0
191	BUGATTI	T 35 C	1,75	1927-1929	>1101	SS	0,35	0,15	0,25	0
192	BUGATTI	T 35 compressore	1,75	1927-1929	>1101	SS	0,35	0,15	0,25	0
193	BUGATTI	T 37	1,75	1927-1929	>1101	SS	0,35	0,15	0,25	0
194	BUGATTI	T 37 modificata 1100	1,70	1930-1934	>1101	SS	0,30	0,15	0,25	0
195	BUGATTI	T 38	1,70	1927-1929	>1101	S	0,35	0,15	0,20	0
196	BUGATTI	T 39	1,75	1927-1929	>1101	SS	0,35	0,15	0,25	0
197	BUGATTI	T 40	1,75	1927-1929	>1101	S	0,35	0,15	0,20	0,05
198	BUGATTI	T 43	1,65	1930-1934	>1101	S	0,30	0,15	0,20	0
199	BUGATTI	T 43 GS	1,70	1927-1929	>1101	S	0,35	0,15	0,20	0
200	BUGATTI	T 50	1,65	1930-1934	>1101	S	0,30	0,15	0,20	0
201	BUGATTI	T 51	1,70	1930-1934	>1101	SS	0,30	0,15	0,25	0
202	BUGATTI	T 55	1,65	1930-1934	>1101	S	0,30	0,15	0,20	0
203	BUICK	Master Six	1,70	1927-1929	>1101	S	0,35	0,15	0,20	0
204	CAR-GEM CARNEVALLI	FIAT 508 C Sport	1,55	1935-1940	<1100	S	0,25	0,10	0,20	0
205	CAR-GEM CARNEVALLI	FIAT 1100 S	1,65	1947-1949	<1100	SC	0,20	0,10	0,35	0
206	CAR-GEM CARNEVALLI	TT 1100 siluro	1,60	1950-1952	<1100	SC	0,15	0,10	0,35	0
207	CEIRANO	S 150	1,70	1927-1929	>1101	S	0,35	0,15	0,20	0
208	CEIRANO	S 150 VVV	1,65	1930-1934	>1101	S	0,30	0,15	0,20	0
209	CFM	500 barchetta Bertone	1,55	1947-1949	<750	SC	0,20	0	0,35	0
210	CFM	Volkswagen 750 barchetta	1,55	1947-1949	<750	SC	0,20	0	0,35	0
211	CFM	Volkswagen 750 Siluro sport	1,35	1950-1952	<750	S	0,15	0	0,20	0
212	CHEVROLET	Corvette *	1,35	1953-1957	>1101	GT	0,10	0,15	0,10	0
213	CHRYSLER	72 (tutte)	1,70	1927-1929	>1101	SP	0,35	0,15	0,15	0,05
214	CHRYSLER	75	1,70	1927-1929	>1101	SP	0,35	0,15	0,15	0,05
215	CHRYSLER	Saratoga 5300	1,30	1953-1957	>1101	T	0,10	0,15	0	0,05
216	CI-MA	FIAT 500 siluro Morelli carrozzato chiuso	1,40	1947-1949	<750	S	0,20	0	0,20	0
217	CI-MA	Turolla - FIAT berlinetta	1,35	1950-1952	<750	S	0,15	0	0,20	0
218	CISITALIA	202 MM Savonuzzi berlinetta Vignale per Pinin Farina	1,50	1947-1949	<1100	S	0,20	0,10	0,20	0
219	CISITALIA	202 MM spider "razzo"	1,65	1947-1949	<1100	SC	0,20	0,10	0,35	0
220	CISITALIA	202 S MM berlinetta "cassone"	1,65	1947-1949	<1100	SC	0,20	0,10	0,35	0
221	CISITALIA	202 S MM berlinetta aerodinamica	1,65	1947-1949	<1100	SC	0,20	0,10	0,35	0
222	CISITALIA	202 S MM spider (Nuvolari)	1,70	1947-1949	<1100	SC	0,20	0,10	0,35	0,05
223	CISITALIA	202 SC berlinetta Pinin Farina	1,45	1947-1949	<1100	SP	0,20	0,10	0,15	0
224	CISITALIA	202 B berlinetta Pinin Farina	1,45	1950-1952	<1100	SP	0,15	0,10	0,15	0,05
225	CISITALIA	202 B berlinetta Vignale	1,40	1950-1952	<1100	SP	0,15	0,10	0,15	0
226	CISITALIA	202 cabriolet	1,35	1950-1952	<1100	GT	0,15	0,10	0,10	0
227	CISITALIA	202 cabriolet Pinin Farina	1,35	1950-1952	<1100	GT	0,15	0,10	0,10	0

	MARCA MARQUE	MODELLO MODEL	COEFF. Multiplier	CALCULATION FACTOR						WINNER FACTOR
				PERIOD	CLASS	CAT.	PERIOD	CLASS	CAT.	
228	CISITALIA	202 D 2800 cc	1,65	1950-1952	>1101	SC	0,15	0,15	0,35	0
229	CISITALIA	202 spider - hardtop	1,40	1950-1952	<1100	SP	0,15	0,10	0,15	0
230	CITROËN	C4	1,60	1930-1934	>1101	SP	0,30	0,15	0,15	0
231	CITROËN	modello non identificato	1,35	1947-1949	>1101	T	0,20	0,15	0	0
232	CITROËN	15	1,35	1947-1949	>1101	T	0,20	0,15	0	0
233	CITROËN	11 B	1,25	1953-1957	>1101	T	0,10	0,15	0	0
234	CITROËN	modello non identificato	1,25	1953-1957	>1101	T	0,10	0,15	0	0
235	CITROËN	15 Six	1,25	1953-1957	>1101	T	0,10	0,15	0	0
236	CITROËN	2 CV	1,10	1953-1957	<750	T	0,10	0	0	0
237	CITROEN	2 CV Carrozzeria Speciale	1,15	1953-1957	<750	T	0,10	0	0	0,05
238	CITROËN	DS 19	1,25	1953-1957	>1101	T	0,10	0,15	0	0
239	COMIRATO	FIAT 1100	1,60	1935-1940	<1100	SS	0,25	0,10	0,25	0
240	COMIRATO	FIAT 508 spider	1,60	1935-1940	<1100	SS	0,25	0,10	0,25	0
241	COMIRATO	GIL.CO FIAT 1100 siluro	1,70	1947-1949	<1100	SC	0,20	0,10	0,35	0,05
242	CONRERO	Alfa Romeo 1900 berlina Koren	1,60	1953-1957	>1101	SC	0,10	0,15	0,35	0
243	CONRERO	Alfa Romeo 1900 coupè Ghia	1,60	1953-1957	>1101	SC	0,10	0,15	0,35	0
244	COOPER	T25 Bristol	1,60	1953-1957	>1101	SC	0,10	0,15	0,35	0
245	COOPER	Jaguar T33	1,60	1953-1957	>1101	SC	0,10	0,15	0,35	0
246	COUSY	750 Sport *	1,30	1953-1957	<750	S	0,10	0	0,20	0
247	CRIVELLARI	500 A FIAT testa S.I.A.T.A.	1,55	1947-1949	<750	S	0,20	0	0,35	0
248	D.B.	Citroën Spider	1,50	1950-1952	>1101	S	0,15	0,15	0,20	0
249	D.B.	Panhard Berlinetta	1,25	1950-1952	<750	GT	0,15	0	0,10	0
250	D.B.	Panhard X86 berlina	1,30	1950-1952	<750	GT	0,15	0	0,10	0,05
251	D.B.	Panhard Tank	1,50	1953-1957	<750	SC	0,10	0	0,35	0,05
252	D.B.	Panhard 750 S	1,45	1953-1957	<750	SC	0,10	0	0,35	0
253	D.B.	Panhard 750 Berlinetta Zagato	1,45	1953-1957	<750	SC	0,10	0	0,35	0
254	D.B.	Panhard HBR	1,50	1953-1957	<750	SC	0,10	0	0,35	0,05
255	D.B.	Panhard HBR 5	1,30	1953-1957	<1100	GT	0,10	0,10	0,10	0
256	DEUTSCH-BONNET	Panhard HBR spider	1,30	1953-1957	<1100	GT	0,10	0,10	0,10	0
257	D.L. (Derivata Lancia Vici)	Ardea 750 S Benelli - Ortolani	1,50	1950-1952	<750	SC	0,15	0	0,35	0
258	DAGRADA	FIAT 750 siluro	1,50	1950-1952	<750	SC	0,15	0	0,35	0
259	DAGRADA	FIAT 750 spider	1,50	1950-1952	<750	SC	0,15	0	0,35	0
260	DELAGE	D6 75 Sport	1,65	1935-1940	>1101	SS	0,25	0,15	0,25	0
261	DELAHAYE	135 CS	1,65	1935-1940	>1101	SS	0,25	0,15	0,25	0
262	DELAHAYE	135 MS	1,65	1935-1940	>1101	SS	0,25	0,15	0,25	0
263	DELAHAYE	135 MS spider	1,55	1950-1952	>1101	SS	0,15	0,15	0,25	0
264	DELAHAYE	145	1,70	1935-1940	>1101	SS	0,25	0,15	0,25	0,05
265	DELAHAYE	3500	1,35	1947-1949	>1101	T	0,20	0,15	0	0
266	DERBY	1100	1,65	1927-1929	<1100	S	0,35	0,10	0,20	0
267	DIATTO	26	1,70	1927-1929	>1101	S	0,35	0,15	0,20	0
268	DIATTO	30	1,70	1927-1929	>1101	S	0,35	0,15	0,20	0
269	DIATTO	35	1,70	1927-1929	>1101	S	0,35	0,15	0,20	0
270	DKW	Sonderklasse 3=6	1,25	1953-1957	<1100	T	0,10	0,10	0	0,05
271	E.F.A.C.	Stanguellini 750 S	1,45	1953-1957	<750	SC	0,10	0	0,35	0
272	EMANUELLI	FIAT 750 S	1,30	1953-1957	<750	S	0,10	0	0,20	0
273	ERMINI FIAT	1100 Sport Ala d'Oro	1,65	1947-1949	<1100	SC	0,20	0,10	0,35	0
274	ERMINI	1100 berlina Motto	1,60	1950-1952	<1100	SC	0,15	0,10	0,35	0
275	ERMINI	1100 GIL.CO spider Mariani	1,60	1950-1952	<1100	SC	0,15	0,10	0,35	0
276	ERMINI	1100 Sport	1,60	1950-1952	<1100	SC	0,15	0,10	0,35	0
277	ERMINI	GIL.CO 1100 Motto	1,60	1950-1952	<1100	SC	0,15	0,10	0,35	0

	MARCA MARQUE	MODELLO MODEL	COEFF. Multiplier	CALCULATION FACTOR						WINNER FACTOR
				PERIOD	CLASS	CAT.	PERIOD	CLASS	CAT.	
278	ERMINI	tipo 357 Sport 1500 Scaglietti	1,60	1953-1957	1101>	SC	0,10	0,15	0,35	0
279	EXCELSIOR	1100 Ermini GIL.CO spider Colli	1,60	1950-1952	<1100	SC	0,15	0,10	0,35	0
280	F.L. (FIAT LAUREATI)	1100 spider	1,55	1953-1957	<1100	SC	0,10	0,10	0,35	0
281	F.L. (FIAT LAUREATI)	1100 Sport	1,55	1953-1957	<1100	SC	0,10	0,10	0,35	0
282	FACCIOLI	FIAT 750 S	1,50	1950-1952	<750	SC	0,15	0	0,35	0
283	FACCIOLI	Ortolani 750 S	1,35	1950-1952	<750	S	0,15	0	0,20	0
284	FANCIULLINI	250 Sport	1,30	1953-1957	<750	S	0,10	0	0,20	0
285	FERRARI	125 S spider	1,70	1947-1949	>1101	SC	0,20	0,15	0,35	0
286	FERRARI	166 S Coupé Allemano (winner 1948)	1,80	1947-1949	>1101	SC	0,20	0,15	0,35	WOA
287	FERRARI	166 S Spider [ex 125 S]	1,70	1947-1949	>1101	SC	0,20	0,15	0,35	0
288	FERRARI	166 Spider Corsa Ansaloni	1,70	1947-1949	>1101	SC	0,20	0,15	0,35	0
289	FERRARI	166 MM barchetta Touring	1,70	1947-1948	>1100	SC	0,20	0,15	0,35	0
290	FERRARI	166 Inter Spider Corsa Ansaloni	1,70	1947-1949	>1101	SC	0,20	0,15	0,35	0
291	FERRARI	166 MM spider Touring (winner 1949)	1,80	1947-1949	>1101	SC	0,20	0,15	0,35	WOA
292	FERRARI	166 Spider Corsa	1,70	1947-1949	>1101	SC	0,20	0,15	0,35	0
293	FERRARI	159/166 Spider Corsa Ansaloni	1,70	1947-1949	>1101	SC	0,20	0,15	0,35	0
294	FERRARI	166 Inter berlinetta Pinin Farina	1,65	1950-1952	>1101	SC	0,15	0,15	0,35	0
295	FERRARI	166 Inter berlinetta Touring	1,65	1950-1952	>1101	SC	0,15	0,15	0,35	0
296	FERRARI	166 MM berlinetta Touring	1,65	1950-1952	>1101	SC	0,15	0,15	0,35	0
297	FERRARI	166 MM barchetta Touring	1,65	1950-1952	>1101	SC	0,15	0,15	0,35	0
298	FERRARI	166 Inter Spider Corsa Ansaloni passo corto	1,65	1950-1952	>1101	SC	0,15	0,15	0,35	0
299	FERRARI	166 MM berlinetta Zagato	1,65	1950-1952	>1101	SC	0,15	0,15	0,35	0
300	FERRARI	166 MM berlinetta Touring Le Mans	1,65	1950-1952	>1101	SC	0,15	0,15	0,35	0
301	FERRARI	166 MM spider Vignale	1,65	1950-1952	>1101	SC	0,15	0,15	0,35	0
302	FERRARI	166 MM berlinetta Vignale	1,70	1950-1952	>1101	SC	0,15	0,15	0,35	0,05
303	FERRARI	166 Inter berlinetta Touring	1,45	1950-1952	>1101	SP	0,15	0,15	0,15	0
304	FERRARI	166 Inter berlinetta Pinin Farina	1,45	1950-1952	>1101	SP	0,15	0,15	0,15	0
305	FERRARI	166 MM/53 berlinetta Touring Le Mans	1,60	1953-1957	>1101	SC	0,10	0,15	0,35	0
306	FERRARI	166 MM/53 spider Autodromo	1,60	1953-1957	>1101	SC	0,10	0,15	0,35	0
307	FERRARI	166 MM/53 spider Scaglietti	1,60	1953-1957	>1101	SC	0,10	0,15	0,35	0
308	FERRARI	166 MM/53 spider Vignale	1,60	1953-1957	>1101	SC	0,10	0,15	0,35	0
309	FERRARI	166 SC/195 S barchetta Fontana	1,65	1950-1952	>1101	SC	0,15	0,15	0,35	0
310	FERRARI	195 S berlinetta Touring (winner 1950)	1,80	1950-1952	>1101	SC	0,15	0,15	0,35	WOA
311	FERRARI	195 S barchetta Touring	1,65	1950-1952	>1101	SC	0,15	0,15	0,35	0
312	FERRARI	195 Inter coupé Motto	1,45	1950-1952	>1101	SP	0,15	0,15	0,15	0
313	FERRARI	212 Export berlinetta Motto	1,65	1950-1952	>1101	SC	0,15	0,15	0,35	0
314	FERRARI	212 Export berlinetta Vignale	1,65	1950-1952	>1101	SC	0,15	0,15	0,35	0
315	FERRARI	212 Export spider Motto	1,65	1950-1952	>1101	SC	0,15	0,15	0,35	0
316	FERRARI	195 Inter berlinetta Vignale	1,45	1950-1952	>1101	SP	0,15	0,15	0,15	0
317	FERRARI	212 Export berlinetta Touring	1,65	1950-1952	>1101	SC	0,15	0,15	0,35	0
318	FERRARI	212 Export spider Fontana	1,65	1950-1952	>1101	SC	0,15	0,15	0,35	0
319	FERRARI	212 Inter berlinetta Vignale	1,45	1950-1952	>1101	SP	0,15	0,15	0,15	0
320	FERRARI	220 Export spider Vignale	1,60	1953-1957	>1101	SC	0,10	0,15	0,35	0
321	FERRARI	212 Export spider Vignale	1,60	1953-1957	>1101	SC	0,10	0,15	0,35	0
322	FERRARI	212 Export coupé Motto	1,60	1953-1957	>1101	SC	0,10	0,15	0,35	0
323	FERRARI	212 Export barchetta Touring	1,60	1953-1957	>1101	SC	0,10	0,15	0,35	0
324	FERRARI	212 Export berlinetta Touring	1,60	1953-1957	>1101	SC	0,10	0,15	0,35	0
325	FERRARI	212 Inter coupé Vignale	1,40	1953-1957	>1101	SP	0,10	0,15	0,15	0
326	FERRARI	220 S	1,60	1953-1957	>1101	SC	0,10	0,15	0,35	0
327	FERRARI	225 S barchetta Touring	1,65	1950-1952	>1101	SC	0,15	0,15	0,35	0

	MARCA MARQUE	MODELLO MODEL	COEFF. Multiplier	CALCULATION FACTOR						WINNER FACTOR
				PERIOD	CLASS	CAT.	PERIOD	CLASS	CAT.	
328	FERRARI	225 S berlina Vignale	1,65	1950-1952	>1101	SC	0,15	0,15	0,35	0
329	FERRARI	225 S spider Vignale	1,65	1950-1952	>1101	SC	0,15	0,15	0,35	0
330	FERRARI	225 S coupé Vignale	1,60	1953-1957	>1101	SC	0,10	0,15	0,35	0
331	FERRARI	250 MM spider Vignale	1,60	1953-1957	>1101	SC	0,10	0,15	0,35	0
332	FERRARI	250 MM berlina Pinin Farina	1,60	1953-1957	>1101	SC	0,10	0,15	0,35	0
333	FERRARI	250 MM spider Morelli	1,60	1953-1957	>1101	SC	0,10	0,15	0,35	0
334	FERRARI	250 Monza spider Pinin Farina	1,60	1953-1957	>1101	SC	0,10	0,15	0,35	0
335	FERRARI	250 S berlina Vignale (winner 1952)	1,80	1950-1952	>1101	SC	0,15	0,15	0,35	WOA
336	FERRARI	250 GT berlina Scaglietti	1,40	1953-1957	>1101	SP	0,10	0,15	0,15	0
337	FERRARI	250 GT Europa *	1,40	1953-1957	>1101	SP	0,10	0,15	0,15	0
338	FERRARI	250 GT LWB berlina Scaglietti	1,45	1953-1957	>1101	SP	0,10	0,15	0,15	0,05
339	FERRARI	250 GT berlina Pinin Farina	1,40	1953-1957	>1101	SP	0,10	0,15	0,15	0
340	FERRARI	250 GT coupé Boano	1,40	1953-1957	>1101	SP	0,10	0,15	0,15	0
341	FERRARI	250 GTZ coupé corsa Zagato	1,40	1953-1957	>1101	SP	0,10	0,15	0,15	0
342	FERRARI	250 GTZ berlina Zagato	1,40	1953-1957	>1101	SP	0,10	0,15	0,15	0
343	FERRARI	118 LM spider Scaglietti	1,65	1953-1957	>1101	SC	0,10	0,15	0,35	0,05
344	FERRARI	121 LM spider Scaglietti	1,60	1953-1957	>1101	SC	0,10	0,15	0,35	0
345	FERRARI	275 S barchetta Touring	1,65	1950-1952	>1101	SC	0,15	0,15	0,35	0
346	FERRARI	290 MM spider Scaglietti (winner 1956)	1,80	1953-1957	>1101	SC	0,10	0,15	0,35	WOA
347	FERRARI	315 S (winner 1957)	1,80	1953-1957	>1101	SC	0,10	0,15	0,35	WOA
348	FERRARI	335 S spider Scaglietti	1,60	1953-1957	>1101	SC	0,10	0,15	0,35	0
349	FERRARI	340 America barchetta Touring	1,65	1950-1952	>1101	SC	0,15	0,15	0,35	0
350	FERRARI	340 America berlina Vignale (winner 1951)	1,80	1950-1952	>1101	SC	0,15	0,15	0,35	WOA
351	FERRARI	340 America spider Vignale	1,65	1950-1952	>1101	SC	0,15	0,15	0,35	0
352	FERRARI	340 America spider Fontana *	1,65	1950-1952	>1101	SC	0,15	0,15	0,35	0
353	FERRARI	340 Mexico berlina Vignale	1,60	1953-1957	>1101	SC	0,10	0,15	0,35	0
354	FERRARI	340 MM barchetta Touring	1,60	1953-1957	>1101	SC	0,10	0,15	0,35	0
355	FERRARI	340 MM spider Vignale (winner 1953)	1,80	1953-1957	>1101	SC	0,10	0,15	0,35	WOA
356	FERRARI	375 MM berlina Pinin Farina	1,60	1953-1957	>1101	SC	0,10	0,15	0,35	0
357	FERRARI	375 MM spider Pinin Farina	1,60	1953-1957	>1101	SC	0,10	0,15	0,35	0
358	FERRARI	375 Plus spider Pinin Farina	1,60	1953-1957	>1101	SC	0,10	0,15	0,35	0
359	FERRARI	410 SA *	1,60	1953-1957	>1101	SC	0,10	0,15	0,35	0
360	FERRARI	500 Mondial spider Scaglietti	1,65	1953-1957	>1101	SC	0,10	0,15	0,35	0,05
361	FERRARI	500 Mondial berlina Pinin Farina	1,60	1953-1957	>1101	SC	0,10	0,15	0,35	0
362	FERRARI	500 Mondial spider Pinin Farina	1,60	1953-1957	>1101	SC	0,10	0,15	0,35	0
363	FERRARI	500 TRC spider Scaglietti	1,65	1953-1957	>1101	SC	0,10	0,15	0,35	0,05
364	FERRARI	500 TR spider Scaglietti	1,60	1953-1957	>1101	SC	0,10	0,15	0,35	0
365	FERRARI	750 Monza spider Scaglietti	1,60	1953-1957	>1101	SC	0,10	0,15	0,35	0
366	FERRARI	860 Monza spider Scaglietti	1,60	1953-1957	>1101	SC	0,10	0,15	0,35	0
367	FERRERO	FIAT 1100 S	1,45	1950-1952	<1100	S	0,15	0,10	0,20	0
368	FERRY	F750 Renault	1,30	1953-1957	<750	S	0,10	0	0,20	0
369	FIAT	501 S	1,70	1927-1929	>1101	S	0,35	0,15	0,20	0
370	FIAT	501 testa Silvani spider speciale	1,70	1927-1929	>1101	S	0,35	0,15	0,20	0
371	FIAT	509 S	1,70	1927-1929	<1100	S	0,35	0,10	0,20	0,05
372	FIAT	509 S guida interna	1,60	1927-1929	<1100	SP	0,35	0,10	0,15	0
373	FIAT	509 S bateau	1,65	1927-1929	<1100	S	0,35	0,10	0,20	0
374	FIAT	509 SM	1,60	1930-1934	<1100	S	0,30	0,10	0,20	0
375	FIAT	508 "Balilla" 3 marce (tutte/all)	1,55	1930-1934	<1100	SP	0,30	0,10	0,15	0
376	FIAT	508 S "Balilla" berlina aerodinamica	1,55	1930-1934	<1100	SP	0,30	0,10	0,15	0

	MARCA MARQUE	MODELLO MODEL	COEFF. Multiplier	CALCULATION FACTOR						WINNER FACTOR
				PERIOD	CLASS	CAT.	PERIOD	CLASS	CAT.	
377	FIAT	508 S "Balilla" Coppa d'Oro	1,60	1930-1934	<1100	SP	0,30	0,10	0,15	0,05
378	FIAT	508 S "Balilla" Mille Miglia	1,60	1930-1934	<1100	SP	0,30	0,10	0,15	0,05
379	FIAT	508 CS Sport "Balilla" compressore	1,55	1935-1940	<1100	S	0,25	0,10	0,20	0
380	FIAT	508 CS S "Balilla" berlina Ala d'Oro	1,55	1935-1940	<1100	S	0,25	0,10	0,20	0
381	FIAT	508 CS spider Touring	1,55	1935-1940	<1100	S	0,25	0,10	0,20	0
382	FIAT	508 CS MM berlina	1,55	1935-1940	<1100	S	0,25	0,10	0,20	0
383	FIAT	508 C Balilla 1100 (tutte/all)	1,50	1935-1940	<1100	SP	0,25	0,10	0,15	0
384	FIAT	508 L Balilla 1100 (tutte/all)	1,50	1935-1940	<1100	SP	0,25	0,10	0,15	0
385	FIAT	508 Sport "Balilla" gasogeno	1,55	1935-1940	<1100	SP	0,25	0,10	0,15	0,05
	FIAT	1100 [508 C] Sport	1,55	1935-1940	<1100	S	0,25	0,10	0,20	0
	FIAT	1100 [508 C] berlina	1,35	1935-1940	<1100	T	0,25	0,10	0	0
386	FIAT	1100 [508 C] berlina metano	1,35	1935-1940	<1100	T	0,25	0,10	0	0
387	FIAT	1100 [508 C] berlina con compressore	1,50	1935-1940	<1100	SP	0,25	0,10	0,15	0
388	FIAT	1100 [508 C] MM berlina	1,60	1935-1940	<1100	SS	0,25	0,10	0,25	0
389	FIAT	1100 [508 C] MM berlina Savio	1,60	1935-1940	<1100	SS	0,25	0,10	0,25	0
390	FIAT	1100 [508 C] barchetta	1,60	1935-1940	<1100	SS	0,25	0,10	0,25	0
391	FIAT	1100 [508 C] spider	1,60	1935-1940	<1100	SS	0,25	0,10	0,25	0
392	FIAT	1100 [508 C] berlina aerodinamica	1,60	1935-1940	<1100	SS	0,25	0,10	0,25	0
393	FIAT	514	1,60	1930-1934	>1101	SP	0,30	0,15	0,15	0
394	FIAT	514 CA	1,65	1930-1934	>1101	S	0,30	0,15	0,20	0
395	FIAT	514 CA spider sport	1,65	1930-1934	>1101	S	0,30	0,15	0,20	0
396	FIAT	514 MM	1,70	1930-1934	>1101	S	0,30	0,15	0,20	0,05
397	FIAT	514 S	1,70	1930-1934	>1101	S	0,30	0,15	0,20	0,05
398	FIAT	519 S	1,75	1927-1929	>1101	S	0,35	0,15	0,20	0,05
399	FIAT	520	1,65	1927-1929	>1101	SP	0,35	0,15	0,15	0
400	FIAT	520 versioni corsa	1,70	1927-1929	>1101	S	0,35	0,15	0,20	0
401	FIAT	522	1,60	1930-1934	>1101	SP	0,30	0,15	0,15	0
402	FIAT	525 S berlina	1,45	1930-1934	>1101	T	0,30	0,15	0	0
403	FIAT	525 S	1,60	1930-1934	>1101	SP	0,30	0,15	0,15	0
404	FIAT	525 SS	1,65	1930-1934	>1101	S	0,30	0,15	0,20	0
405	FIAT	527 Ardita	1,40	1935-1940	>1101	T	0,25	0,15	0	0
406	FIAT	2800 *	1,40	1935-1940	>1101	T	0,25	0,15	0	0
407	FIAT	1100 berlina	1,30	1947-1949	<1100	T	0,20	0,10	0	0
408	FIAT	1100 S MM (gobbone)	1,50	1947-1949	<1100	S	0,20	0,10	0,20	0
409	FIAT	1100 S	1,50	1947-1949	<1100	S	0,20	0,10	0,20	0
410	FIAT	1100 S barchetta	1,65	1947-1949	<1100	SC	0,20	0,10	0,35	0
411	FIAT	1100 S	1,45	1950-1952	<1100	S	0,15	0,10	0,20	0
412	FIAT	1100 S barchetta	1,60	1950-1952	<1100	SC	0,15	0,10	0,35	0
413	FIAT	1100 hardtop Ala d'Oro	1,50	1947-1949	<1100	S	0,20	0,10	0,20	0
414	FIAT	1100 Metano	1,30	1947-1949	<1100	T	0,20	0,10	0	0
415	FIAT	1100 S berlina "Gobbone"	1,55	1947-1949	<1100	S	0,20	0,10	0,20	0,05
416	FIAT	1100 B spider Monviso	1,30	1947-1949	<1100	T	0,20	0,10	0	0
417	FIAT	1100 B berlina	1,30	1947-1949	<1100	T	0,15	0,10	0	0,05
418	FIAT	1100 siluro	1,65	1947-1949	<1100	SC	0,20	0,10	0,35	0
419	FIAT	1100 spider Ala d'Oro	1,50	1947-1949	<1100	S	0,20	0,10	0,20	0
420	FIAT	1100 barchetta	1,65	1947-1949	<1100	SC	0,20	0,10	0,35	0
421	FIAT	1100 coupé	1,50	1947-1949	<1100	S	0,20	0,10	0,20	0
422	FIAT	1100 coupé Ghia "Supergioiello"	1,50	1947-1949	<1100	S	0,20	0,10	0,20	0
423	FIAT	1100 S coupé Allemano	1,50	1947-1949	<1100	S	0,20	0,10	0,20	0
424	FIAT	1100 E berlina	1,30	1950-1952	<1100	T	0,15	0,10	0	0,05

	MARCA MARQUE	MODELLO MODEL	COEFF. Multiplier	CALCULATION FACTOR						WINNER FACTOR
				PERIOD	CLASS	CAT.	PERIOD	CLASS	CAT.	
425	FIAT	1100 ES berlina Pinin Farina	1,35	1950-1952	<1100	GT	0,15	0,10	0,10	0
426	FIAT	1100 S berlina Bertone	1,40	1950-1952	>1101	GT	0,15	0,15	0,10	0
427	FIAT	1100 S Rocco Motto	1,45	1950-1952	<1100	S	0,15	0,10	0,20	0
428	FIAT	1100 S siluro	1,60	1950-1952	<1100	SS	0,15	0,10	0,35	0
429	FIAT	1100/103 berlina	1,25	1953-1957	<1100	T	0,10	0,10	0	0,05
430	FIAT	1100/103 TV berlina	1,25	1953-1957	<1100	T	0,10	0,10	0	0,05
431	FIAT	1100/103 TV coupé Pininfarina	1,35	1953-1957	<1100	GT	0,10	0,10	0,10	0,05
432	FIAT	1100/103 TV spider	1,30	1953-1957	<1100	GT	0,10	0,10	0,10	0
433	FIAT	1400 berlina	1,35	1950-1952	>1101	T	0,15	0,15	0	0,05
434	FIAT	1400 A Diesel	1,25	1953-1957	>1101	T	0,10	0,15	0	0
435	FIAT	1500 Berlina (anteguerra)	1,45	1935-1940	>1101	T	0,25	0,15	0	0,05
436	FIAT	1500 Berlina (dopoguerra)	1,35	1947-1949	>1101	T	0,20	0,15	0	0
437	FIAT	1500 berlina Viotti	1,50	1935-1940	>1101	GT	0,25	0,15	0,10	0
438	FIAT	1500 cabriolet Viotti	1,50	1935-1940	>1101	GT	0,25	0,15	0,10	0
439	FIAT	1500 spider	1,50	1935-1940	>1101	GT	0,25	0,15	0,10	0
440	FIAT	1500 sport	1,55	1947-1949	>1101	S	0,20	0,15	0,20	0
441	FIAT	500	1,25	1950-1952	<750	GT	0,15	0	0,10	0
442	FIAT	500 A "Topolino"	1,30	1935-1940	<750	T	0,25	0	0	0,05
443	FIAT	500 A testa S.I.A.T.A.	1,45	1935-1940	<750	S	0,25	0	0,20	0
444	FIAT	500 testa S.I.A.T.A.	1,45	1935-1940	<750	S	0,25	0	0,20	0
445	FIAT	500 siluro	1,50	1935-1940	<750	SS	0,25	0	0,25	0
446	FIAT	500 spider	1,50	1935-1940	<750	SS	0,25	0	0,25	0
447	FIAT	500 sport	1,40	1947-1949	<750	S	0,20	0	0,20	0
448	FIAT	500 barchetta	1,40	1947-1949	<750	S	0,20	0	0,20	0
449	FIAT	500 B "Topolino"	1,25	1947-1949	<750	T	0,20	0	0	0,05
450	FIAT	500 C "Belvedere"	1,15	1950-1952	<750	T	0,15	0	0	0
451	FIAT	500 C "Topolino"	1,20	1950-1952	<750	T	0,15	0	0	0,05
452	FIAT	500 C "Topolino" testa Superba	1,25	1950-1952	<750	GT	0,15	0	0,10	0
453	FIAT	1900 berlina	1,25	1953-1957	>1101	T	0,10	0,15	0	0
454	FIAT	600	1,15	1953-1957	<750	T	0,10	0	0	0,05
455	FIAT	600 coupé	1,20	1953-1957	<750	GT	0,10	0	0,10	0
456	FIAT	SIATA 750 Sport "Fenocchio"	1,40	1947-1949	<750	S	0,20	0	0,20	0
457	FIAT	750 sport	1,40	1947-1949	<750	S	0,20	0	0,20	0
458	FIAT	750 Sport	1,30	1953-1957	<750	S	0,10	0	0,20	0
459	FIAT	8V berlina	1,45	1950-1952	>1101	SP	0,15	0,15	0,15	0
460	FIAT	8V berlina Vignale	1,40	1953-1957	>1101	SP	0,10	0,15	0,15	0
461	FIAT	8V berlina Zagato	1,45	1953-1957	>1101	SP	0,10	0,15	0,15	0,05
462	FIAT	Campagnola	1,30	1950-1952	>1101	T	0,15	0,15	0	0
463	FIAT-SIMCA	1100 [508 C] barchetta Grolleau-Deho	1,60	1935-1940	<1100	SS	0,25	0,10	0,25	0
464	FICAI	1100 S FIAT coupé Allemano	1,45	1950-1952	<1100	S	0,15	0,10	0,20	0
465	FICAI	1100 S FIAT coupé Allemano	1,50	1947-1949	<1100	S	0,20	0,10	0,20	0
466	FICAI	Nardi 750 Norton bicilindrico	1,40	1953-1957	<1100	S	0,10	0,10	0,20	0
467	FONA	FIAT 1100 3 carburatori spider	1,60	1950-1952	<1100	SC	0,15	0,10	0,35	0
468	FONA	FIAT 1100 S	1,60	1950-1952	<1100	SC	0,15	0,10	0,35	0
469	FONA	FIAT 1100 S berlina	1,65	1947-1949	<1100	SC	0,20	0,10	0,35	0
470	FONA	FIAT 1100 S siluro	1,60	1950-1952	<1100	SC	0,15	0,10	0,35	0
471	FONA	FIAT 1100 siluro	1,65	1947-1949	<1100	SC	0,20	0,10	0,35	0
472	FONTANELLA	FIAT 500 siluro	1,40	1947-1949	<750	S	0,20	0	0,20	0
473	FORD	Taurus	1,30	1953-1957	>1101	T	0,10	0,15	0	0,05
474	FORD [GB]	Zephyr	1,25	1953-1957	>1101	T	0,10	0,15	0	0

	MARCA MARQUE	MODELLO MODEL	COEFF. Multiplier	CALCULATION FACTOR						WINNER FACTOR
				PERIOD	CLASS	CAT.	PERIOD	CLASS	CAT.	
475	FORD [USA]	A	1,60	1930-1934	>1101	SP	0,30	0,15	0,15	0
476	FORD [USA]	B 8V	1,60	1930-1934	>1101	SP	0,30	0,15	0,15	0
477	FORD [USA]	Thunderbird	1,35	1953-1957	>1101	GT	0,10	0,15	0,10	0
478	FRAZER NASH-B.M.W.	328	1,65	1935-1940	>1101	S	0,25	0,15	0,20	0,05
479	FRAZER - NASH	High Speed	1,55	1947-1949	>1101	S	0,20	0,15	0,20	0
480	FRAZER - NASH	Le Mans coupé	1,45	1953-1957	>1101	S	0,10	0,15	0,20	0
481	FRAZER - NASH	Le Mans Replica	1,50	1950-1952	>1101	S	0,15	0,15	0,20	0
482	FRAZER - NASH	Mille Miglia	1,55	1947-1949	>1101	S	0,20	0,15	0,20	0
483	FRAZER - NASH	Fast Tourer Bristol	1,55	1947-1949	>1101	S	0,20	0,15	0,20	0
484	FREDIANI	Lancia Ardea 750 Mariani	1,45	1953-1957	<750	SC	0,10	0	0,35	0
485	FURIA	DKW telaio FIAT 1100	1,55	1947-1949	>1101	S	0,20	0,15	0,20	0
486	GARAGE VITTORIA	FIAT 1100 barchetta Pietroboni	1,70	1947-1949	>1101	SC	0,20	0,15	0,35	0
487	GARAVINI	FIAT 1500 spider	1,75	1935-1940	>1101	SC	0,25	0,15	0,35	0
488	GEROSA	FIAT 750	1,50	1950-1952	<750	SC	0,15	0	0,35	0
489	GEROSA	GIL.CO 750 S.I.A.T.A. berlinetta	1,35	1950-1952	<750	S	0,15	0	0,20	0
490	GHIRINGHELLI-FIAT	500 A SIATA Zagato	1,30	1935-1940	<750	T	0,25	0	0	0
491	GIANNINI	FIAT 500 berlinetta Scuderia Parioli	1,50	1935-1940	<750	SS	0,25	0	0,25	0
492	GIANNINI	750 S berlinetta	1,55	1947-1949	<750	SC	0,20	0	0,35	0
493	GIANNINI	750 S siluro	1,55	1947-1949	<750	SC	0,20	0	0,35	0
494	GIANNINI	750 S barchetta	1,55	1947-1949	<750	SC	0,20	0	0,35	0
495	GIANNINI	750 S siluro	1,50	1950-1952	<750	SC	0,15	0	0,35	0
496	GIAUR	750 berlinetta	1,50	1950-1952	<750	SC	0,15	0	0,35	0
497	GIANNINI	750 S barchetta	1,50	1950-1952	<750	SC	0,15	0	0,35	0
498	GIANNINI	750 S barchetta	1,45	1953-1957	<750	SC	0,10	0	0,35	0
499	GIAUR	750 S	1,50	1950-1952	<750	SC	0,15	0	0,35	0
500	GIAUR	750 S berlinetta	1,50	1950-1952	<750	SC	0,15	0	0,35	0
501	GIAUR	750 S	1,45	1953-1957	<750	SC	0,10	0	0,35	0
502	GIAUR	"San Remo" 750 berlinetta Motto	1,45	1953-1957	<750	SC	0,10	0	0,35	0
503	GIAUR	750 spider Campana	1,45	1953-1957	<750	SC	0,10	0	0,35	0
504	GIL.CO	FIAT 1100 Siluro Mariani	1,65	1947-1949	<1100	SC	0,20	0,10	0,35	0
505	GIL.CO	FIAT 1100 barchetta Fontana	1,60	1950-1952	<1100	SC	0,15	0,10	0,35	0
506	GIL.CO	FIAT 1100 Sport	1,60	1950-1952	<1100	SC	0,15	0,10	0,35	0
507	GIL.CO	S.I.A.T.A. 750 Siluro	1,50	1950-1952	<750	SC	0,15	0	0,35	0
508	GIL.CO	FIAT 1100 spider Barbero	1,55	1953-1957	<1100	SC	0,10	0,10	0,35	0
509	GIUSTI	Testadoro "Daniela" siluro Zagato	1,55	1947-1949	<750	SC	0,20	0	0,35	0
510	GIUSTI-ROSELLI	Testadoro "Daniela" spider Zagato	1,55	1947-1949	<750	SC	0,20	0	0,35	0
511	GOLIATH	GP 700	1,10	1953-1957	<750	T	0,10	0	0	0
512	GORDINI	Simca 1100 Sport	1,65	1947-1949	<1100	SC	0,20	0,10	0,35	0
513	GORDINI	T15 S 1500	1,60	1953-1957	>1101	SC	0,10	0,15	0,35	0
514	GORDINI	T20 S 2000	1,60	1953-1957	>1101	SC	0,10	0,15	0,35	0
515	GORDINI	T24 S 3000	1,60	1953-1957	>1101	SC	0,10	0,15	0,35	0
516	GORDINI	T8 S 1100	1,60	1953-1957	>1101	SC	0,10	0,15	0,35	0
517	GPG	Stoewer 2000 barchetta Colli	1,70	1947-1949	>1101	SC	0,20	0,15	0,35	0
518	GRAHAM-PAIGE	modello non identificato 8000 cc	1,45	1930-1934	>1101	T	0,30	0,15	0	0
519	GUARDIANI	FIAT 500 spider	1,55	1947-1949	<750	SC	0,20	0	0,35	0
520	GUITIN	1100 barchetta	1,55	1953-1957	<1100	SC	0,10	0,10	0,35	0
521	HEALEY	2400 Elliott	1,40	1947-1949	>1101	T	0,20	0,15	0	0,05
522	HEALEY	Duncan Drone	1,55	1947-1949	>1101	S	0,20	0,15	0,20	0
523	HEALEY	Beutler Coupé	1,50	1947-1949	>1101	SP	0,20	0,15	0,15	0
524	HEALEY	2400 Westland	1,55	1947-1949	>1101	SP	0,20	0,15	0,15	0,05

	MARCA MARQUE	MODELLO MODEL	COEFF. Multiplier	CALCULATION FACTOR						WINNER FACTOR
				PERIOD	CLASS	CAT.	PERIOD	CLASS	CAT.	
525	HEALEY	2400 Silverstone (D-Type)	1,55	1947-1949	>1101	S	0,20	0,15	0,20	0
526	HEALEY	2400 Silverstone (E-Type)	1,50	1950-1952	>1101	S	0,15	0,15	0,20	0
527	HISPANO-SUIZA	HB 6	1,65	1930-1934	>1101	S	0,30	0,15	0,20	0
528	HOTCHKISS	20 CV *	1,55	1947-1949	>1101	S	0,20	0,15	0,20	0
529	HW (POI HWM)	Alta 2000 Sport	1,65	1950-1952	>1101	SC	0,15	0,15	0,35	0
530	HWM	Jaguar S 3400 cm3	1,60	1953-1957	>1101	SC	0,10	0,15	0,35	0
531	HWM	Jaguar S 3800 cm3	1,60	1953-1957	>1101	SC	0,10	0,15	0,35	0
532	ICOT	FIAT 1100	1,50	1947-1949	<1100	S	0,20	0,10	0,20	0
533	ISO	Isetta 236 cc	1,15	1953-1957	<750	T	0,10	0	0	0,05
534	ISOTTA FRASCHINI	8A SS torpedo Sala	1,75	1927-1929	>1101	S	0,35	0,15	0,20	0,05
535	ITALA	61	1,70	1927-1929	>1101	S	0,35	0,15	0,20	0
536	ITALA	61 berlina aerodinamica	1,70	1927-1929	>1101	S	0,35	0,15	0,20	0
537	ITALA	65	1,65	1930-1934	>1101	S	0,30	0,15	0,20	0
538	ITALA	75V spider	1,65	1930-1934	>1101	S	0,30	0,15	0,20	0
539	ITALA	speciale Diesel	1,60	1930-1934	>1101	SP	0,30	0,15	0,15	0
540	ITALA	speciale gasogeno	1,55	1935-1940	>1101	SP	0,25	0,15	0,15	0
541	JAGUAR	C - Type	1,65	1950-1952	>1101	SC	0,15	0,15	0,35	0
542	JAGUAR	D - Type	1,60	1953-1957	>1101	SC	0,10	0,15	0,35	0
543	JAGUAR	Mark VII	1,30	1950-1952	>1101	T	0,15	0,15	0	0
544	JAGUAR	XK 120 OTS roadster Lightweight	1,50	1947-1949	>1101	SP	0,20	0,15	0,15	0
545	JAGUAR	XK 120 OTS roadster	1,40	1950-1952	>1101	GT	0,15	0,15	0,10	0
546	JAGUAR	XK 120 coupé	1,40	1950-1952	>1101	GT	0,15	0,15	0,10	0
547	JAGUAR	Xk 140 OTS roadster	1,40	1953-1957	>1101	GT	0,10	0,15	0,10	0,05
548	JORDAN	Blue Boy	1,70	1927-1929	>1101	S	0,35	0,15	0,20	0
549	JORDAN	JE "Blueboy" tourer	1,65	1930-1934	>1101	S	0,30	0,15	0,20	0
550	KIEFT	Turner *	1,60	1953-1957	>1101	SC	0,10	0,15	0,35	0
551	KURTIS CHRYSLER	500 X "Caballo de Hierro" 6.420 cm3	1,60	1953-1957	>1101	SC	0,10	0,15	0,35	0
552	LA SALLE	Series 303 torpedo	1,75	1927-1929	>1101	S	0,35	0,15	0,20	0,05
553	LAGONDA	M45 Rapide *	1,65	1935-1940	>1101	SS	0,25	0,15	0,25	0
554	LANCIA	Lambda berlina	1,50	1927-1929	>1101	T	0,35	0,15	0	0
555	LANCIA	Lambda Tipo 214 (corto)	1,75	1927-1929	>1101	SS	0,35	0,15	0,25	0
556	LANCIA	Lambda Tipo 216 e 217 (lungo)	1,50	1927-1929	>1101	T	0,35	0,15	0	0
557	LANCIA	Lambda Tipo 218 e 219 (corto)	1,75	1927-1929	>1101	SS	0,35	0,15	0,25	0
558	LANCIA	Lambda Tipo 221 e 223 (corto)	1,75	1927-1929	>1101	SS	0,35	0,15	0,25	0
559	LANCIA	Lambda Tipo 222 e 224 (lungo)	1,50	1927-1929	>1101	T	0,35	0,15	0	0
560	LANCIA	Lambda torpedo Tipo 218 Corsa	1,80	1927-1929	>1101	SS	0,35	0,15	0,25	0,05
561	LANCIA	Lambda spider Tipo 221 Casaro	1,80	1927-1929	>1101	SS	0,35	0,15	0,25	0,05
562	LANCIA	Lambda spider corsa	1,75	1927-1929	>1101	SS	0,35	0,15	0,25	0
563	LANCIA	Lambda speciale (motore Dilambda)	1,80	1930-1934	>1101	SS	0,35	0,15	0,25	0,05
564	LANCIA	Dilambda	1,70	1930-1934	>1101	S	0,30	0,15	0,20	0,05
565	LANCIA	Artena	1,65	1930-1934	>1101	S	0,30	0,15	0,20	0
566	LANCIA	Astura	1,60	1930-1934	>1101	SP	0,30	0,15	0,15	0
567	LANCIA	Astura berlina Lotti	1,45	1930-1934	>1101	T	0,30	0,15	0	0
568	LANCIA	Astura spider corsa	1,65	1935-1940	>1101	SS	0,25	0,15	0,25	0
569	LANCIA	Augusta	1,55	1935-1940	>1101	SP	0,25	0,15	0,15	0
570	LANCIA	Augusta berlina	1,55	1935-1940	>1101	SP	0,25	0,15	0,15	0
571	LANCIA	Augusta berlinetta aerodinamica	1,55	1935-1940	>1101	SP	0,25	0,15	0,15	0
572	LANCIA	Augusta Belna Cabriolet	1,55	1935-1940	>1101	SP	0,25	0,15	0,15	0
573	LANCIA	Augusta cabriolet	1,55	1935-1940	>1101	SP	0,25	0,15	0,15	0
574	LANCIA	Aprilia spider Touring "Ala spessa"	1,60	1935-1940	>1101	S	0,25	0,15	0,20	0

	MARCA MARQUE	MODELLO MODEL	COEFF. Multiplier	CALCULATION FACTOR						WINNER FACTOR
				PERIOD	CLASS	CAT.	PERIOD	CLASS	CAT.	
575	LANCIA	Aprilia Spider Zagato	1,70	1935-1940	>1101	SS	0,25	0,15	0,25	0,05
576	LANCIA	Aprilia berlinetta aerodinamica Pinin Farina	1,60	1935-1940	>1101	S	0,25	0,15	0,20	
577	LANCIA	Aprilia berlinetta aerodinamica Boneschi	1,60	1935-1940	>1101	S	0,25	0,15	0,20	0
578	LANCIA	Aprilia Spider	1,65	1935-1940	>1101	S	0,25	0,15	0,20	0,05
579	LANCIA	Aprilia spider Colli	1,60	1935-1940	>1101	S	0,25	0,15	0,20	0
580	LANCIA	Aprilia spider Colli hardtop	1,60	1935-1940	>1101	S	0,25	0,15	0,20	0
581	LANCIA	Aprilia berlina 1350	1,55	1935-1940	>1101	SP	0,25	0,15	0,15	0
582	LANCIA	Aprilia berlina 1500	1,40	1947-1949	>1101	T	0,20	0,15	0	0,05
583	LANCIA	Aprilia Sport	1,75	1947-1949	>1101	SC	0,20	0,15	0,35	0,05
584	LANCIA	Aprilia spider	1,70	1947-1949	>1101	SC	0,20	0,15	0,35	0
585	LANCIA	Ardea berlina 1^ e 2^ serie	1,40	1935-1940	<1100	T	0,25	0,10	0	0,05
586	LANCIA	Ardea berlina 3^ e 4^ serie	1,35	1947-1949	<1100	T	0,20	0,10	0	0,05
587	LANCIA	Ardea 750 S	1,45	1953-1957	<750	SC	0,10	0	0,35	0
588	LANCIA	Aurelia B12 berlina	1,25	1953-1957	>1101	T	0,10	0,15	0	0
589	LANCIA	Aurelia B21 berlina	1,35	1950-1952	>1101	T	0,15	0,15	0	0,05
590	LANCIA	Aurelia B22 berlina	1,25	1953-1957	>1101	T	0,10	0,15	0	0
591	LANCIA	Aurelia B20 GT 2000 berlinetta Pinin Farina	1,45	1950-1952	>1101	GT	0,15	0,15	0,10	0,05
592	LANCIA	Aurelia B20 GT 2500 berlinetta Pinin Farina	1,40	1953-1957	>1101	GT	0,10	0,15	0,10	0,05
593	LANCIA	Aurelia B24 spider "America" Pinin Farina	1,35	1953-1957	>1101	GT	0,10	0,15	0,10	0
594	LANCIA	Aurelia B50 GT coupé Vignale	1,40	1950-1952	>1101	GT	0,15	0,15	0,10	0
595	LANCIA	D20 berlinetta Pinin Farina	1,60	1953-1957	>1101	SC	0,10	0,15	0,35	0
596	LANCIA	D24 Spider (winner 1954)	1,80	1953-1957	>1101	SC	0,10	0,15	0,35	WOA
597	LANCIA	Appia	1,20	1953-1957	<1100	T	0,10	0,10	0	0
598	LANCIA	Appia coupé Motto	1,30	1953-1957	<1100	GT	0,10	0,10	0,10	0
599	LANCIA	Appia GTZ	1,35	1953-1957	<1100	GT	0,10	0,10	0,10	0,05
600	LA SALLE	303 TORPEDO	1,75	1927-1929	>1101	S	0,35	0,15	0,20	0,05
601	LEONE	FIAT 1100 Sport	1,65	1947-1949	<1100	SC	0,20	0,10	0,35	0
602	LEONE	Lancia - FIAT 1100 barchetta	1,70	1935-1940	<1100	SC	0,25	0,10	0,35	0
603	LEONE	Savonuzzi 1100 FIAT barchetta	1,65	1947-1949	<1100	SC	0,20	0,10	0,35	0
604	LEONE	Savonuzzi 1100 FIAT siluro	1,60	1950-1952	<1100	SC	0,15	0,10	0,35	0
605	LINCOLN	Capri	1,45	1953-1957	>1101	S	0,10	0,15	0,20	0
606	LOMBARD	AL3 *	1,65	1927-1929	<1100	S	0,35	0,10	0,20	0
607	LORRAINE-DIETRICH	B/3/6	1,70	1927-1929	>1101	S	0,35	0,15	0,20	0
608	LOTUS	Eleven Climax	1,55	1953-1957	<1100	SC	0,10	0,10	0,35	0
609	LOTUS	Lotus Mk IX Climax *	1,55	1953-1957	<1100	SC	0,10	0,10	0,35	0
610	MAESTRI-BARTOLINI	Giannini 750 spider	1,50	1950-1952	<750	SC	0,15	0	0,35	0
611	MARDAL	750 Giannini - GIL.CO Fontana	1,50	1950-1952	<750	SC	0,15	0	0,35	0
612	MARINO (BRANDOLI)	FIAT 1100 Sport	1,55	1953-1957	<1100	SC	0,10	0,10	0,35	0
613	MARINO (BRANDOLI)	FIAT 1100 S Berlinetta	1,60	1950-1952	<1100	SC	0,15	0,10	0,35	0
614	MARINO (BRANDOLI)	FIAT 750 barchetta	1,45	1953-1957	<750	SC	0,10	0	0,35	0
615	MARINO (BRANDOLI)	FIAT 750 berlinetta	1,45	1953-1957	<750	SC	0,10	0	0,35	0
616	MARINO (BRANDOLI)	FIAT 750 S berlinetta	1,50	1950-1952	<750	SC	0,15	0	0,35	0
617	MARZOTTO-FERRARI	212 Export berlinetta Reggiani - Fontana "Uovo"	1,65	1950-1952	>1101	SC	0,15	0,15	0,35	0
618	MARZOTTO-FERRARI	212 Export spider Reggiani - Fontana	1,65	1950-1952	>1101	SC	0,15	0,15	0,35	0
619	MARZOTTO-FERRARI	340 America spider Fontana	1,65	1950-1952	>1101	SC	0,15	0,15	0,35	0
620	MASERATI	Tipo 26 B MM	1,75	1927-1929	>1101	SS	0,35	0,15	0,25	0
621	MASERATI	Tipo 26 MM spider	1,75	1927-1929	>1101	SS	0,35	0,15	0,25	0
622	MASERATI	Tipo 26 M Sport	1,70	1930-1934	>1101	SS	0,30	0,15	0,25	0
623	MASERATI	Tipo 26 C 1100	1,70	1930-1934	<1100	SS	0,30	0,10	0,25	0,05

	MARCA MARQUE	MODELLO MODEL	COEFF. Multiplier	CALCULATION FACTOR						WINNER FACTOR
				PERIOD	CLASS	CAT.	PERIOD	CLASS	CAT.	
624	MASERATI	Tipo 26 C 1500	1,70	1930-1934	>1101	SS	0,30	0,15	0,25	0
625	MASERATI	4 CTR 1100	1,70	1930-1934	<1100	SS	0,30	0,10	0,25	0,05
626	MASERATI	4CS 1100	1,70	1930-1934	<1100	SS	0,30	0,10	0,25	0,05
627	MASERATI	4 CS 1500 Campari & Sorniotti	1,70	1930-1934	>1101	SS	0,30	0,15	0,25	0
628	MASERATI	4 CS 1500	1,70	1935-1940	>1101	SS	0,25	0,15	0,25	0,05
629	MASERATI	6C/34	1,75	1935-1940	>1101	SC	0,25	0,15	0,35	0
630	MASERATI	Tipo 8C 26B 2000 Menarini	1,65	1935-1940	>1101	SS	0,25	0,15	0,25	0
631	MASERATI	Tipo 26 spider Menarini	1,65	1935-1940	>1101	SS	0,25	0,15	0,25	0
632	MASERATI	A6 GCS berlina	1,70	1947-1949	>1101	SC	0,20	0,15	0,35	0
633	MASERATI	A6 GCS spider	1,70	1947-1949	>1101	SC	0,20	0,15	0,35	0
634	MASERATI	A6 1500 berlina Pinin Farina	1,55	1947-1949	>1101	S	0,20	0,15	0,20	0
635	MASERATI	A6 1500 berlina	1,45	1950-1952	>1101	SP	0,15	0,15	0,15	0
636	MASERATI	A6 GCS/53 Fantuzzi	1,65	1953-1957	>1101	SC	0,10	0,15	0,35	0,05
637	MASERATI	A6 GCS /53 spider Vignale	1,60	1953-1957	>1101	SC	0,10	0,15	0,35	0
638	MASERATI	A6 GCS 2500	1,60	1953-1957	>1101	SC	0,10	0,15	0,35	0
639	MASERATI	A6 G 54 Zagato	1,45	1953-1957	>1101	S	0,10	0,15	0,20	0
640	MASERATI	150 S	1,60	1953-1957	>1101	SC	0,10	0,15	0,35	0
641	MASERATI	200 SI	1,60	1953-1957	>1101	SC	0,10	0,15	0,35	0
642	MASERATI	300 S spider Fantuzzi	1,60	1953-1957	>1101	SC	0,10	0,15	0,35	0
643	MASERATI	350 S spider Fantuzzi	1,60	1953-1957	>1101	SC	0,10	0,15	0,35	0
644	MASERATI	450 S spider Fantuzzi	1,60	1953-1957	>1101	SC	0,10	0,15	0,35	0
645	MASETTI	FIAT 500 siluro Marmini	1,55	1947-1949	<750	SC	0,20	0	0,35	0
646	MERCEDES-BENZ	710 SS *	1,65	1930-1934	>1101	S	0,30	0,15	0,20	0
647	MERCEDES-BENZ	710 SSK	1,75	1930-1934	>1101	SS	0,30	0,15	0,25	0,05
648	MERCEDES-BENZ	720 SSKL (winner 1931)	1,80	1930-1934	>1101	SS	0,30	0,15	0,25	WOA
649	MERCEDES-BENZ	300 SL Prototipo	1,65	1950-1952	>1101	SC	0,15	0,15	0,35	0
650	MERCEDES-BENZ	300 SLR (winner 1955)	1,80	1953-1957	>1101	SC	0,10	0,15	0,35	WOA
651	MERCEDES-BENZ	180 D	1,30	1953-1957	>1101	T	0,10	0,15	0	0,05
652	MERCEDES-BENZ	220	1,25	1953-1957	>1101	T	0,10	0,15	0	0
653	MERCEDES-BENZ	220 A	1,30	1953-1957	>1101	T	0,10	0,15	0	0,05
654	MERCEDES-BENZ	300 SL (W198)	1,40	1953-1957	>1101	GT	0,10	0,15	0,10	0,05
655	MERCEDES-BENZ	SC 180 Coupé	1,35	1953-1957	>1101	GT	0,10	0,15	0,10	0
656	MERCEDES-BENZ	190 SL	1,35	1953-1957	>1101	GT	0,10	0,15	0,10	0
657	MG	K-3 Magnette	1,70	1930-1934	<1100	SS	0,30	0,10	0,25	0,05
658	MG	C-Type "Midget" compressore	1,55	1930-1934	<750	SS	0,30	0	0,25	0
659	MG	SA berlina	1,55	1935-1940	>1101	SP	0,25	0,15	0,15	0
660	MG	Q-Type *	1,45	1935-1940	<750	S	0,25	0	0,20	0
661	MG	PB	1,55	1935-1940	>1101	SP	0,25	0,15	0,15	0
662	MG	TB *	1,60	1935-1940	>1101	S	0,25	0,15	0,20	0
663	MG	TF (1250 cc) *	1,35	1953-1957	>1101	GT	0,10	0,15	0,10	0
664	MG	Magnette berlina	1,25	1953-1957	>1101	T	0,10	0,15	0	0
665	MG	MG A	1,35	1953-1957	>1101	GT	0,10	0,15	0,10	0
666	MG	MG A "WORKS"	1,40	1953-1957	>1101	SP	0,10	0,15	0,15	0
667	MILAN (RUGGERI)	S.I.A.T.A. 1100 berlina Viotti	1,55	1935-1940	<1100	S	0,25	0,10	0,20	0
668	MOR & SCA	FIAT 500 Sport	1,45	1947-1949	<750	SC	0,10	0	0,35	0
669	MORETTI	600 MM	1,35	1950-1952	<750	S	0,15	0	0,20	0
670	MORETTI	750 berlina	1,10	1953-1957	<750	T	0,10	0	0	0
671	MORETTI	750 berlina Zagato	1,30	1953-1957	<750	S	0,10	0	0,20	0
672	MORETTI	750 coupé	1,20	1953-1957	<750	GT	0,10	0	0,10	0
673	MORETTI	750 Gran Sport berlina	1,30	1953-1957	<750	S	0,10	0	0,20	0

	MARCA MARQUE	MODELLO MODEL	COEFF. Multiplier	CALCULATION FACTOR						WINNER FACTOR
				PERIOD	CLASS	CAT.	PERIOD	CLASS	CAT.	
674	MORETTI	750 S	1,50	1950-1952	<750	SC	0,15	0	0,35	0
675	MORETTI	750 S berlina	1,30	1953-1957	<750	S	0,10	0	0,20	0
676	MORETTI	750 S berlinetta	1,45	1953-1957	<750	SC	0,10	0	0,35	0
677	MORETTI	750 S spider	1,45	1953-1957	<750	SC	0,10	0	0,35	0
678	MORETTINI-FLORIDA	FIAT 508 spider Sport Internazionale	1,60	1935-1940	<1100	SS	0,25	0,10	0,25	0
679	MOTOR RG (REMO GATTAI)	FIAT RG 1 750 S		1947-1949	<750	SC	0,20	0	0,35	0
680	MOTOR RG (REMO GATTAI)	FIAT-LANCIA RG 1 1100 S	1,65	1947-1949	<1100	SC	0,20	0,10	0,35	0
681	NARDI-DANESE	750 B.M.W. Motto	1,55	1947-1949	<750	SC	0,20	0	0,35	0
682	NARDI-DANESE	Alfa Romeo 6C 2500 SS spider S.A.I.L.	1,55	1947-1949	>1101	S	0,20	0,15	0,20	0
683	NARDI-DANESE	Alfa Romeo 6C 2500 SS siluro "Revelli"	1,70	1947-1949	>1101	SC	0,20	0,15	0,35	0
684	NARDI-DANESE	Alfa Romeo 6C 2500 SS coupè "Revelli"	1,70	1947-1949	>1101	SC	0,20	0,15	0,35	0
685	NARDI-DANESE	B.M.W. 750 siluro	1,35	1950-1952	<750	S	0,15	0	0,20	0
686	NARDI-DANESE	1100 S FIAT berlinetta	1,45	1950-1952	<1100	S	0,15	0,10	0,20	0
687	NARDI-DANESE	815 Auto Avio 1500 spider	1,65	1950-1952	>1101	SC	0,15	0,15	0,35	0
688	NARDI-DANESE	750 Sport	1,50	1950-1952	<750	SC	0,15	0	0,35	0
689	NARDI-DANESE	"Marco" spider Morelli	1,60	1953-1957	>1101	SC	0,10	0,15	0,35	0
690	NARDI-DANESE	2000 S	1,60	1953-1957	>1101	SC	0,10	0,15	0,35	0
691	NARDI-DANESE	750 S	1,45	1953-1957	<750	SC	0,10	0	0,35	0
692	NARDI-DUBOIS	Peugeot berlinetta Frua	1,45	1953-1957	>1101	S	0,10	0,15	0,20	0
693	NASH-HEALEY	Coupè 4143 cm3	1,50	1950-1952	>1101	S	0,20	0,15	0,15	0
694	NASH-HEALEY	Sports 4138 cm3	1,45	1950-1952	>1101	SP	0,15	0,15	0,15	0
695	NASH-HEALEY	Sport (barchetta) 4143 cm3	1,50	1950-1952	>1101	S	0,20	0,15	0,15	0
696	NSU-FIAT	750 sport	1,40	1947-1949	<750	S	0,20	0	0,20	0
697	O.M.	469	1,75	1927-1929	>1101	SS	0,35	0,15	0,25	0
698	O.M.	665 S Superba 2000 cm3 (winner 1927)	1,80	1927-1929	>1101	SS	0,35	0,15	0,25	WOA
699	O.M.	665 S MM Superba 2000 cm3	1,80	1927-1929	>1101	SS	0,35	0,15	0,25	0,05
700	O.M.	665 S MM Superba 2200 cm3	1,80	1927-1929	>1101	SS	0,35	0,15	0,25	0,05
701	O.M.	665 SS MM Superba 2200 cm3	1,80	1927-1929	>1101	SS	0,35	0,15	0,25	0,05
702	O.M.	665 N 2000 cm3	1,50	1927-1929	>1101	T	0,35	0,15	0	0
703	O.R.C.A.	1100 spider	1,50	1947-1949	<1100	S	0,20	0,10	0,20	0
704	O.S.C.A.	MT4 1350	1,70	1947-1949	>1101	SC	0,20	0,15	0,35	0
705	O.S.C.A.	MT4 1100	1,65	1950-1952	<1100	SC	0,15	0,10	0,35	0,05
706	O.S.C.A.	MT4 1100 siluro	1,60	1950-1952	<1100	SC	0,15	0,10	0,35	0
707	O.S.C.A.	MT4 1350 berlinetta Frua	1,65	1950-1952	>1101	SC	0,15	0,15	0,35	0
708	O.S.C.A.	MT4 1100 2AD	1,65	1950-1952	<1100	SC	0,15	0,10	0,35	0,05
709	O.S.C.A.	MT4 1100 2AD hardtop	1,60	1950-1952	<1100	SC	0,15	0,10	0,35	0
710	O.S.C.A.	MT4 1100 2AD berlinetta Vignale	1,55	1953-1957	<1100	SC	0,10	0,10	0,35	0
711	O.S.C.A.	MT4 1500 2AD	1,65	1953-1957	>1101	SC	0,10	0,15	0,35	0,05
712	O.S.C.A.	2000 S	1,60	1953-1957	>1101	SC	0,10	0,15	0,35	0
713	O.S.C.A.	S 187 - 750	1,50	1953-1957	<750	SC	0,10	0	0,35	0,05
714	O.S.C.A.	S 950	1,60	1953-1957	<1100	SC	0,10	0,10	0,35	0,05
715	O.S.C.A.	S 1500	1,60	1953-1957	>1101	SC	0,10	0,15	0,35	0
716	O.S.C.A.	TN 1500	1,60	1953-1957	>1101	SC	0,10	0,15	0,35	0
717	O.S.F.A.	FIAT - Lancia 750 spider	1,55	1947-1949	<750	SC	0,20	0	0,35	0
718	O.S.F.A.	FIAT - Lancia Ardea 750 barchetta	1,55	1947-1949	<750	SC	0,20	0	0,35	0
719	O.S.F.A.	FIAT 750 barchetta	1,50	1950-1952	<750	SC	0,15	0	0,35	0
720	O.S.F.A.	Lancia 750 barchetta	1,45	1953-1957	<750	SC	0,10	0	0,35	0
721	O.S.F.A.	GIL.CO Ardea 750 Spider	1,45	1953-1957	<750	SC	0,10	0	0,35	0
722	OLDSMOBILE	88 5300 cc	1,25	1953-1957	>1101	T	0,10	0,15	0	0

	MARCA MARQUE	MODELLO MODEL	COEFF. Multiplier	CALCULATION FACTOR						WINNER FACTOR
				PERIOD	CLASS	CAT.	PERIOD	CLASS	CAT.	
723	ORLANDO	FIAT 1100 siluro	1,45	1950-1952	<1100	S	0,15	0,10	0,20	0
724	ORTOLANI	Faccioli FIAT 1100 siluro	1,45	1950-1952	<1100	S	0,15	0,10	0,20	0
725	OVERLAND	3000	1,65	1930-1934	>1101	S	0,30	0,15	0,20	0
726	P.F.L.	Aprilia berlina Viotti	1,35	1947-1949	>1101	T	0,20	0,15	0	0
727	PAGANELLI-LANCIA	Aurelia B 20 2000 sport	1,60	1953-1957	>1101	SC	0,10	0,15	0,35	0
728	PANHARD ET LEVASSOR	Dyna	1,20	1950-1952	<750	T	0,15	0	0	0,05
729	PANHARD ET LEVASSOR	Dyna	1,10	1953-1957	<750	T	0,10	0	0	0
730	PANHARD ET LEVASSOR	Dyna X86 berlina Allemano	1,35	1953-1957	<750	S	0,10	0	0,20	0,05
731	PANHARD ET LEVASSOR	Dyna X86	1,15	1950-1952	<750	T	0,15	0	0	0
732	PANHARD ET LEVASSOR	Dyna X86 berlina	1,25	1950-1952	<750	GT	0,15	0	0,10	0
733	PANHARD ET LEVASSOR	Dyna barchetta	1,50	1950-1952	<750	SC	0,15	0	0,35	0
734	PANHARD ET LEVASSOR	Dyna berlina	1,20	1953-1957	<750	GT	0,10	0	0,10	0
735	PANHARD ET LEVASSOR	Dyna 130 S	1,20	1953-1957	<1100	T	0,10	0,10	0	0
736	PANHARD ET LEVASSOR	Dyna X87	1,10	1953-1957	<750	T	0,10	0	0	0
737	PANHARD ET LEVASSOR	Dyna spider	1,20	1953-1957	<750	GT	0,10	0	0,10	0
738	PANHARD ET LEVASSOR	Dyna tipo 54	1,10	1953-1957	<750	T	0,10	0	0	0
739	PANHARD ET LEVASSOR	Dyna Z	1,20	1953-1957	<1100	T	0,10	0,10	0	0
740	PANHARD ET LEVASSOR	Monopole berlina aerodinamica	1,30	1953-1957	<750	S	0,10	0	0,20	0
741	PARIANI	OSCA MT4 1350	1,55	1947-1949	<750	SC	0,20	0	0,35	0
742	PARISOTTO	750 Pasqualin barchetta	1,50	1950-1952	<750	SC	0,15	0	0,35	0
743	PARISOTTO	Giannini 750 S	1,45	1953-1957	<750	SC	0,10	0	0,35	0
744	PASQUALIN	FIAT 750 spider	1,55	1947-1949	<750	SC	0,20	0	0,35	0
745	PASQUALIN	Giannini - FIAT spider	1,50	1950-1952	<750	SC	0,15	0	0,35	0
746	PASQUALIN	GIANNINI FIAT 750 S	1,55	1950-1952	<750	SC	0,15	0	0,35	0,05
747	PASQUALIN	FIAT 750 S	1,50	1950-1952	<750	SC	0,15	0	0,35	0
748	PASQUALIN	Giannini 750 spider	1,45	1953-1957	<750	SC	0,10	0	0,35	0
749	PATRIARCA	FIAT 750 spider	1,55	1947-1949	<750	SC	0,20	0	0,35	0
750	PATRIARCA	FIAT 750 S	1,50	1950-1952	<750	SC	0,15	0	0,35	0
751	PATRIARCA	FIAT 1100 Sport	1,60	1950-1952	<1100	SC	0,15	0,10	0,35	0
752	PATRIARCA	Giannini berlina Faina	1,55	1950-1952	<750	SC	0,15	0	0,35	0,05
753	PATRIARCA	Giannini siluro Faina	1,50	1950-1952	<750	SC	0,15	0	0,35	0
754	PATRIARCA	Giannini 750 berlina Zagato	1,45	1953-1957	<750	SC	0,10	0	0,35	0
755	PATRIARCA	Giannini 750 barchetta	1,45	1953-1957	<750	SC	0,10	0	0,35	0
756	PEUGEOT	5 HP spider tipo MM	1,70	1927-1929	<750	S	0,35	0,10	0,20	0,05
757	PEUGEOT	5 HP tipo MM	1,65	1927-1929	<1100	S	0,35	0,10	0,20	0
758	PEUGEOT	203	1,40	1950-1952	>1101	GT	0,15	0,15	0,10	0
759	PEUGEOT	203	1,30	1953-1957	>1101	T	0,10	0,15	0	0,05
760	PEUGEOT	203 Speciale	1,45	1953-1957	>1101	S	0,10	0,15	0,20	0
761	PEUGEOT	203 coupé	1,35	1953-1957	>1101	GT	0,10	0,15	0,10	0
762	PEUGEOT	403 1300	1,25	1953-1957	>1101	T	0,10	0,15	0	0
763	PEUGEOT	403 1500	1,30	1953-1957	>1101	T	0,10	0,15	0	0,05
764	PICON	Panhard 750 Sport	1,45	1953-1957	<750	SC	0,10	0	0,35	0

	MARCA MARQUE	MODELLO MODEL	COEFF. Multiplier	CALCULATION FACTOR						WINNER FACTOR
				PERIOD	CLASS	CAT.	PERIOD	CLASS	CAT.	
765	PLATÉ	Alfa Romeo 6C 2300 siluro Zagato	1,75	1935-1940	>1101	SC	0,25	0,15	0,35	0
766	PORSCHE	356 1100	1,40	1950-1952	<1100	GT	0,15	0,10	0,10	0,05
767	PORSCHE	356 1290	1,35	1953-1957	>1101	GT	0,10	0,15	0,10	0
768	PORSCHE	356 1290 Super	1,40	1953-1957	>1101	GT	0,10	0,15	0,10	0,05
769	PORSCHE	356 A 1290	1,35	1953-1957	>1101	GT	0,10	0,15	0,10	0
770	PORSCHE	356 1500 SL [carrozzeria alluminio]	1,40	1950-1952	>1101	GT	0,15	0,15	0,10	0
771	PORSCHE	356 1500	1,45	1950-1952	>1101	GT	0,15	0,15	0,10	0,05
772	PORSCHE	356 1500	1,35	1953-1957	>1101	GT	0,10	0,15	0,10	0
773	PORSCHE	356 1500 Super	1,40	1953-1957	>1101	GT	0,10	0,15	0,10	0,05
774	PORSCHE	356 A 1600	1,35	1953-1957	>1101	GT	0,10	0,15	0,10	0
775	PORSCHE	356 A 1600 Super	1,35	1953-1957	>1101	GT	0,10	0,15	0,10	0
776	PORSCHE	356 1500 GS Carrera	1,45	1953-1957	>1101	SP	0,10	0,15	0,15	0,05
777	PORSCHE	356 A 1500 GS Carrera	1,45	1953-1957	>1101	SP	0,10	0,15	0,15	0,05
778	PORSCHE	356 1500 Speedster	1,40	1953-1957	>1101	GT	0,10	0,15	0,10	0,05
779	PORSCHE	550 Spyder RS	1,65	1953-1957	>1101	SC	0,10	0,15	0,35	0,05
780	PORSCHE	550 Spyder A/1500 RS	1,65	1953-1957	>1101	SC	0,10	0,15	0,35	0,05
781	PULIDORI	FIAT 750	1,55	1947-1949	<750	SC	0,20	0	0,35	0
782	PULIDORI	FIAT 750 siluro	1,50	1950-1952	<750	SC	0,15	0	0,35	0
783	RALLY	ABC 1100 (modèles competition)	1,70	1927-1929	<1100	SS	0,35	0,10	0,25	0
784	RENAULT	4 CV	1,20	1950-1952	<750	T	0,15	0	0	0,05
785	RENAULT	4CV/1063	1,20	1950-1952	<750	T	0,15	0	0	0,05
786	RENAULT	4 CV berlinetta	1,20	1953-1957	<750	GT	0,10	0	0,10	0
787	RENAULT	4 CV coupé	1,20	1953-1957	<750	GT	0,10	0	0,10	0
788	RENAULT	4 CV coupé speciale	1,20	1953-1957	<750	GT	0,10	0	0,10	0
789	RENAULT	4 CV spider	1,30	1953-1957	<750	S	0,10	0	0,20	0
790	RENAULT	4CV/1063 berlinetta Allemano	1,25	1953-1957	<750	GT	0,10	0	0,10	0,05
791	RENAULT	750 berlinetta	1,25	1950-1952	<750	GT	0,15	0	0,10	0
792	RENAULT	750 S	1,30	1953-1957	<750	S	0,10	0	0,20	0
793	RENAULT	Dauphine	1,25	1953-1957	<1100	T	0,10	0,10	0	0,05
794	RICCI	B.M.W. 750 spider	1,55	1947-1949	<750	SC	0,20	0	0,35	0
795	RILEY	Sprite TT	1,60	1935-1940	>1101	S	0,25	0,15	0,20	0
796	RIVA-PAGANI	1100 FIAT barchetta	1,60	1950-1952	<1100	SC	0,15	0,10	0,35	0
797	ROCCA	1100	1,60	1930-1934	<1100	S	0,30	0,10	0,20	0
798	ROSELLI	1100 barchetta Colli	1,65	1947-1949	<1100	SC	0,20	0,10	0,35	0
799	ROSELLI	FIAT 1100 barchetta aerodinamica Colli	1,70	1935-1940	<1100	SC	0,25	0,10	0,35	0
800	ROVELLI	FIAT 1100 Testadoro Coupé Castagna	1,65	1947-1949	<1100	SC	0,20	0,10	0,35	0
801	ROVELLI	FIAT 1100 spider hard-top	1,65	1947-1949	<1100	SC	0,20	0,10	0,35	0
802	ROVER	75	1,25	1953-1957	>1101	T	0,10	0,15	0	0
803	S.I.A.T.A	FIAT 521 C	1,70	1927-1929	>1101	S	0,35	0,15	0,20	0
804	S.I.A.T.A	FIAT 514 S	1,60	1930-1934	>1101	SP	0,30	0,15	0,15	0
805	S.I.A.T.A.	FIAT 514 MM	1,65	1930-1934	≥1101	S	0,30	0,15	0,20	0
806	S.I.A.T.A	FIAT 514 compressore	1,60	1930-1934	>1101	SP	0,30	0,15	0,15	0
807	S.I.A.T.A	FIAT 508 S berlinetta Ghia	1,55	1930-1934	<1100	SP	0,30	0,10	0,15	0
808	S.I.A.T.A	FIAT 508 S	1,55	1930-1934	<1100	SP	0,30	0,10	0,15	0
809	S.I.A.T.A	FIAT 508 S compressore berlinetta Ghia	1,50	1935-1940	<1100	SP	0,25	0,10	0,15	0
810	S.I.A.T.A	"Gran Sport" spider 636 cm3	1,50	1935-1940	<750	S	0,25	0	0,20	0,05
811	S.I.A.T.A	FIAT 508 CS berlinetta	1,35	1935-1940	<1100	T	0,25	0,10	0	0
812	S.I.A.T.A	FIAT 1500 Spider	1,45	1935-1940	>1101	T	0,25	0,15	0	0,05
813	S.I.A.T.A	FIAT 1100 MM berlinetta Viotti	1,55	1935-1940	<1100	S	0,25	0,10	0,20	0
814	S.I.A.T.A	FIAT 500 spider Zagato	1,45	1935-1940	<750	S	0,25	0	0,20	0

	MARCA MARQUE	MODELLO MODEL	COEFF. Multiplier	CALCULATION FACTOR						WINNER FACTOR
				PERIOD	CLASS	CAT.	PERIOD	CLASS	CAT.	
815	S.I.A.T.A	FIAT 1100 spider	1,60	1935-1940	<1100	SS	0,25	0,10	0,25	0
816	S.I.A.T.A	FIAT 500 spider	1,50	1935-1940	<750	SS	0,25	0	0,25	0
817	S.I.A.T.A	FIAT 500 Pescara	1,50	1935-1940	<750	SS	0,25	0	0,25	0
818	S.I.A.T.A	FIAT 750 spider	1,50	1935-1940	<750	SS	0,25	0	0,25	0
819	S.I.A.T.A	FIAT 750 spider Bertone	1,55	1947-1949	<750	SC	0,20	0	0,35	0
820	S.I.A.T.A	FIAT 750 sport	1,55	1947-1949	<750	SC	0,20	0	0,35	0
821	S.I.A.T.A	TC 500 sport	1,55	1947-1949	<750	SC	0,20	0	0,35	0
822	S.I.A.T.A	750 spider	1,30	1953-1957	<750	S	0,10	0	0,20	0
823	S.I.A.T.A	FIAT 750 barchetta	1,55	1947-1949	<750	SC	0,20	0	0,35	0
824	S.I.A.T.A	750 S	1,50	1950-1952	<750	SC	0,15	0	0,35	0
825	S.I.A.T.A	Daina Gran Sport Stabilimenti Farina	1,45	1950-1952	>1101	SP	0,15	0,15	0,15	0
826	S.I.A.T.A	Daina Sport Stabilimenti Farina Coupé	1,45	1950-1952	>1101	SP	0,15	0,15	0,15	0
827	S.I.A.T.A	Daina Sport Berlinetta Bertone	1,45	1950-1952	>1101	SP	0,15	0,15	0,15	0
828	S.I.A.T.A	SC 750 siluro	1,50	1950-1952	<750	SC	0,15	0	0,35	0
829	S.I.A.T.A	208 S berlinetta Pinin Farina	1,50	1950-1952	>1101	S	0,15	0,15	0,20	0
830	S.I.A.T.A	Amica	1,30	1953-1957	<750	S	0,10	0	0,20	0
831	S.I.A.T.A	300 BC berlinetta	1,25	1953-1957	<750	SP	0,10	0	0,15	0
832	S.I.A.T.A	1100 GT	1,35	1953-1957	<1100	SP	0,10	0,10	0,15	0
833	S.I.A.T.A	1100 TV Coupé Vignale	1,35	1953-1957	<1100	SP	0,10	0,10	0,15	0
834	S.I.A.T.A	Daina Sport Coupé 1250 Pinin Farina	1,45	1953-1957	>1101	S	0,10	0,15	0,20	0
835	S.I.A.T.A	1250 GT	1,45	1953-1957	>1101	S	0,10	0,15	0,20	0
836	S.I.A.T.A	1250 GT Zagato	1,35	1953-1957	>1101	GT	0,10	0,15	0,10	0
837	S.I.A.T.A	300 BC convertibile hardtop	1,30	1953-1957	<750	S	0,10	0	0,20	0
838	S.I.A.T.A	FIAT 750 berlinetta	1,30	1953-1957	<750	S	0,10	0	0,20	0
839	SAAB	93	1,15	1953-1957	<750	T	0,10	0	0	0,05
840	SAIL	FIAT barchetta 1100	1,65	1947-1949	<1100	SC	0,20	0,10	0,35	0
841	SALMSON	AL 1100 bialbero siluro corsa	1,65	1927-1929	<1100	S	0,35	0,10	0,20	0
842	SALMSON	AL 1100 siluro corsa	1,70	1927-1929	<1100	SS	0,35	0,10	0,25	0
843	SALMSON	AL 1100 spider corsa	1,70	1927-1929	<1100	SS	0,35	0,10	0,25	0
844	SALMSON	AL 1100	1,65	1927-1929	<1100	S	0,35	0,10	0,20	0
845	SALMSON	1100	1,65	1927-1929	<1100	S	0,35	0,10	0,20	0
846	SALMSON	2300	1,35	1953-1957	>1101	GT	0,10	0,15	0,10	0
847	SALMSON	2300 Sport	1,35	1953-1957	>1101	GT	0,10	0,15	0,10	0
848	SAM	C25 F spider	1,65	1927-1929	<1100	S	0,35	0,10	0,20	0
849	SAM	C25 J spider	1,65	1927-1929	<1100	S	0,35	0,10	0,20	0
850	SCAT CEIRANO	S 150 VVV	1,65	1930-1934	>1101	S	0,30	0,15	0,20	0
851	SCUDERIA ITALFRANCE	Panhard Dyna X86 berlinetta Allemano	1,30	1950-1952	<750	SP	0,15	0	0,15	0
852	SCUDERIA ITALFRANCE	Panhard Dyna berlinetta Colli "disco volante"	1,45	1953-1957	<750	SC	0,10	0	0,35	0
853	SCUDERIA ITALFRANCE	Panhard Dyna X 86 Berlinetta Colli	1,30	1953-1957	<750	S	0,10	0	0,20	0
854	SCUDERIA ITALFRANCE	Panhard Dyna X 86 Berlinetta Zagato	1,30	1953-1957	<750	S	0,10	0	0,20	0
855	SCUDERIA ITALFRANCE	Panhard Dyna X 86 Spider Allemano	1,30	1953-1957	<750	S	0,10	0	0,20	0
856	SIGHINOLFI	Ermini 1100 siluro	1,60	1950-1952	<1100	SC	0,15	0,10	0,35	0
857	SIGHINOLFI	FIAT 1100 S	1,55	1953-1957	<1100	SC	0,10	0,10	0,35	0
858	SIGHINOLFI	FIAT 1100 siluro Campana	1,65	1947-1949	<1100	SC	0,20	0,10	0,35	0
859	SIMCA	Aronde	1,30	1950-1952	>1101	T	0,15	0,15	0	0
860	SIMCA	Aronde S	1,25	1953-1957	>1101	T	0,10	0,15	0	0
861	SIMCA-GORDINI	1100 Sport *	1,65	1947-1949	<1100	SC	0,20	0,10	0,35	0

	MARCA MARQUE	MODELLO MODEL	COEFF. Multiplier	CALCULATION FACTOR						WINNER FACTOR
				PERIOD	CLASS	CAT.	PERIOD	CLASS	CAT.	
862	SIMCA-GORDINI	2000 S Berlinetta *	1,70	1947-1949	>1101	SC	0,20	0,15	0,35	0
863	STAL	750 GT *	1,35	1950-1952	<750	S	0,15	0	0,20	0
864	STANGA	FIAT 500A testa S.I.A.T.A. barchetta Cervi & Corna	1,55	1947-1949	<750	SC	0,20	0	0,35	0
865	STANGA	FIAT 750 S	1,45	1953-1957	<750	SC	0,10	0	0,35	0
866	STANGA	Giannini 750 barchetta Motto	1,50	1950-1952	<750	SC	0,15	0	0,35	0
867	STANGA	Giannini 750 berlinetta Motto	1,45	1953-1957	<750	SC	0,10	0	0,35	0
868	STANGA	Giannini 750 siluro Motto	1,50	1950-1952	<750	SC	0,15	0	0,35	0
869	STANGUELLINI	500 Spider spider Torricelli	1,55	1935-1940	<750	SS	0,25	0	0,25	0,05
870	STANGUELLINI	FIAT 1100 spider Touring	1,60	1935-1940	<1100	SS	0,25	0,10	0,25	0
871	STANGUELLINI	1100 Hard Top	1,65	1935-1940	<1100	SS	0,25	0,10	0,25	0,05
872	STANGUELLINI	FIAT 1100 hardtop Carrozzeria Torricelli	1,60	1935-1940	<1100	SS	0,25	0,10	0,25	0
873	STANGUELLINI	FIAT 1100 spider Torricelli	1,60	1935-1940	<1100	SS	0,25	0,10	0,25	0
874	STANGUELLINI	FIAT 500 testa S.I.A.T.A. spider Torricelli	1,50	1935-1940	<750	SS	0,25	0	0,25	0
875	STANGUELLINI	1100 spider	1,65	1947-1949	<1100	SC	0,20	0,10	0,35	0
876	STANGUELLINI	1100 berlinetta Bertone	1,40	1947-1949	<1100	GT	0,20	0,10	0,10	0
877	STANGUELLINI	1100 spider Ala d'Oro	1,65	1947-1949	<1100	SC	0,20	0,10	0,35	0
878	STANGUELLINI	1100 hard-top Ala d'Oro	1,65	1947-1949	<1100	SC	0,20	0,10	0,35	0
879	STANGUELLINI	1100 Sport	1,65	1947-1949	<1100	SC	0,20	0,10	0,35	0
880	STANGUELLINI	2800 spider	1,70	1947-1949	>1101	SC	0,20	0,15	0,35	0
881	STANGUELLINI	750 S	1,55	1947-1949	<750	SC	0,20	0	0,35	0
882	STANGUELLINI	1100 hardtop	1,60	1950-1952	<1100	SC	0,15	0,10	0,35	0
883	STANGUELLINI	750 Siluro	1,50	1950-1952	<750	SC	0,15	0	0,35	0
884	STANGUELLINI	750 spider Campana	1,45	1953-1957	<750	SC	0,10	0	0,35	0
885	STANGUELLINI	1100 barchetta	1,60	1950-1952	<1100	SC	0,15	0,10	0,35	0
886	STANGUELLINI	1100 Sport	1,55	1953-1957	<1100	SC	0,10	0,10	0,35	0
887	STUDEBAKER	Golden Hawk	1,45	1953-1957	>1101	S	0,10	0,15	0,20	0
888	SUNBEAM	Rapier	1,30	1953-1957	>1101	T	0,10	0,15	0	0,05
889	SUPERBA	FIAT 750 S	1,45	1953-1957	<750	SC	0,10	0	0,35	0
890	SVA	Giannini 750 Sport	1,50	1950-1952	<750	SC	0,15	0	0,35	0
891	TALBOT [GB]	AV 105 S	1,65	1930-1934	>1101	S	0,30	0,15	0,20	0
892	TALBOT-LAGO [F]	T 150C	1,65	1935-1940	>1101	SS	0,25	0,15	0,25	0
893	TALBOT-LAGO [F]	T26 GS	1,65	1950-1952	>1101	SC	0,15	0,15	0,35	0
894	TESTADORO-BRANCA	FIAT 750	1,50	1950-1952	<750	SC	0,15	0	0,35	0
895	TINARELLI	Lancia Aprilia barchetta	1,65	1935-1940	>1101	SS	0,25	0,15	0,25	0
896	TINARELLI	Ermioni 1100 siluro	1,60	1950-1952	<1100	SC	0,15	0,10	0,35	0
897	TRIUMPH	TR2 Sports	1,45	1953-1957	>1101	SP	0,10	0,15	0,15	0,05
898	TRIUMPH	TR 3 Sports	1,35	1953-1957	>1101	GT	0,10	0,15	0,10	0
899	TRIUMPH	TR 3 Sports Works	1,40	1953-1957	>1101	SP	0,10	0,15	0,15	0
900	TUROLLA	FIAT 1100	1,65	1947-1949	<1100	SC	0,20	0,10	0,35	0
901	TUROLLA	FIAT 1100 S	1,65	1947-1949	<1100	SC	0,20	0,15	0,35	0
902	TUROLLA	FIAT 1500 spider	1,70	1947-1949	>1101	SC	0,20	0,15	0,35	0
903	TUROLLA	FIAT 500 A testa S.I.A.T.A.	1,55	1947-1949	<750	SC	0,20	0	0,35	0
904	TUROLLA	FIAT 500 A testa S.I.A.T.A. coupé Morelli	1,55	1947-1949	<750	SC	0,20	0	0,35	0
905	TUROLLA	FIAT 750 siluro	1,50	1950-1952	<750	SC	0,15	0	0,35	0
906	TUROLLA	FIAT 750 barchetta	1,50	1950-1952	<750	SC	0,15	0	0,35	0
907	TUROLLA	FIAT 750 berlinetta Morelli	1,50	1950-1952	<750	SC	0,15	0	0,35	0
908	TUROLLA	FIAT 750 Sport	1,55	1947-1949	<750	SC	0,20	0	0,35	0
909	URANIA	750 S	1,50	1950-1952	<750	SC	0,15	0	0,35	0
910	URANIA	B.M.W. 750 siluro	1,55	1947-1949	<750	SC	0,20	0	0,35	0

	MARCA MARQUE	MODELLO MODEL	COEFF. Multiplier	CALCULATION FACTOR						WINNER FACTOR
				PERIOD	CLASS	CAT.	PERIOD	CLASS	CAT.	
911	VERITAS	Comet RS *	1,60	1953-1957	>1101	SC	0,10	0,15	0,35	0
912	VERITAS	Panhard Dyna Gran Sport spider	1,50	1950-1952	<750	SC	0,15	0	0,35	0
913	VIBERTI	Aprilia berlina aerodinamica "Casa"	1,65	1935-1940	>1101	SS	0,25	0,15	0,25	0
914	VOISIN	C 14 3000 cm3	1,70	1927-1929	>1101	S	0,35	0,15	0,20	0
915	VOLKSWAGEN	"Maggiolino" motore Porsche 1.290 cm3	1,40	1953-1957	>1101	SP	0,10	0,15	0,15	0
916	VOLKSWAGEN	1100 "Maggiolino"	1,25	1950-1952	<1100	T	0,15	0,10	0	0
917	VOLKSWAGEN	1200 "Maggiolino"	1,25	1953-1957	>1101	T	0,10	0,15	0	0
918	VOLPINI	B.M.W. 328 barchetta	1,70	1947-1949	>1101	SC	0,20	0,15	0,35	0
919	VOLPINI	FIAT 1100 berlina Frua	1,40	1953-1957	<1100	S	0,10	0,10	0,20	0
920	VOLPINI	Lancia Aprilia carrozzeria Tenconi	1,45	1947-1949	>1101	GT	0,20	0,15	0,10	0
921	VOLPINI	Lancia Aprilia	1,40	1950-1952	>1101	T	0,15	0,15	0,10	0
922	ZAGATO	FIAT 1500 spider	1,60	1935-1940	>1101	S	0,25	0,15	0,20	0
923	ZAGATO	FIAT 500 testa S.I.A.T.A. spider	1,60	1935-1940	>1101	S	0,25	0,15	0,20	0
924	ZAGATO	Lancia Aprilia spider	1,60	1935-1940	>1101	S	0,25	0,15	0,20	0
925	ZAGATO	FIAT 500 berlina panoramica	1,35	1950-1952	<750	S	0,15	0	0,20	0
926	ZAGATO	FIAT 750 MM berlina	1,30	1950-1952	<750	GT	0,15	0	0,10	0,05
927	ZAGATO	FIAT 1100 E berlina	1,40	1950-1952	>1101	GT	0,15	0,15	0,10	0
928	ZAGATO	FIAT 750 berlina	1,25	1950-1952	<750	GT	0,15	0	0,10	0
929	ZAGATO	FIAT 8V spider	1,45	1953-1957	>1101	S	0,10	0,15	0,20	0
930	ZAGATO	FIAT 8V berlina	1,50	1953-1957	>1101	S	0,10	0,15	0,20	0,05
931	ZAGATO	FIAT 750	1,30	1953-1957	<750	S	0,10	0	0,20	0
932	ZAGATO	FIAT 1100 GT	1,35	1953-1957	>1101	GT	0,10	0,15	0,10	0
933	ZAGATO	FIAT 1100 berlina	1,40	1953-1957	<1100	SP	0,10	0,10	0,15	0,05
934	ZAGATO	FIAT 1100/103 TV	1,30	1953-1957	<1100	GT	0,10	0,10	0,10	0
935	ZAGATO	FIAT 1100	1,40	1953-1957	<1100	S	0,10	0,10	0,20	0
936	ZAGATO	FIAT 600 berlina	1,20	1953-1957	<750	GT	0,10	0	0,10	0
937	ZAGATO	FIAT 600 coupé	1,20	1953-1957	<750	GT	0,10	0	0,10	0
938	ZAGATO	Lancia Appia GTZ	1,35	1953-1957	<1100	GT	0,10	0,10	0,10	0,05
939	ZAGATO	FIAT 1100 coupé	1,30	1953-1957	<1100	GT	0,10	0,10	0,10	0
940	ZAGATO	SIATA 1400 Sport	1,45	1953-1957	>1101	S	0,10	0,15	0,20	0
941	ZANNINI	750 S FIAT	1,45	1953-1957	<750	SC	0,10	0	0,35	0
942	ZANUSSI	FIAT 750 Sport MM	1,55	1947-1949	<750	SC	0,20	0	0,35	0
943	ZANUSSI	FIAT Fontebasso 750 Sport	1,50	1950-1952	<750	SC	0,15	0	0,35	0

* VETTURE ISCRITTE ALLA CORSA MA CHE NON HANNO PRESO IL VIA.

* CARS ENTERED IN THE RACE BUT WHICH HAVE NOT STARTED.

Significato Sigle e Abbreviazioni / Overview of acronyms and abbreviations:

- AC (AUTO CARRIERS LTD)
- A.L.F. (AVALLE LANCIA FIORIO)
- ALCA (ANONIMA LOMBARDA CABOTAGGIO AEREO)
- AMP (ALFA MASERATI PRETI)
- B.M.W. (BAYERISCHE MOTOREN WERKE)
- B.N.C. (BOLLACK, NETTER E CIE)
- CARGEM (CARNEVALI GERONIMO)
- CFM (CHINELLATO FRANCESCONI MESTRE)
- CI-MA (CICOGNANI MARCELLO) D.B. (DEUTSCH BONNET)
- D.L. (DERIVATA LANCIA VICI)
- E.F.A.C. (SOCIÉTÉ ECURIE FRANÇAIS AUTOMOBILES COMPÉTITION)
- F.L. (FIAT LAUREATI)
- FIAT (FABBRICA ITALIANA AUTOMOBILI TORINO)
- GIAUR (GIANNINI - URANIA)
- GILCO (GILBERTO COLOMBO)
- GPG (GIANNI PIETRO GENOVA)
- GUI TIN (GUIDOTTI TINARELLI)
- MARDAL (MARZOTTO UMBERTO - DAL MORO)
- MG (MORRIS GARAGE)
- O.M. (OFFICINE MECCANICHE)
- O.R.C.A. (OFFICINA RIPARAZIONI COSTRUZIONE AUTOVEICOLI)
- O.S.C.A. (OFFICINE SPECIALIZZATE COSTRUZIONE)

AUTOMOBILI)

- O.S.F.A. (OFFICINA SPECIALIZZATA FACCIOLI ALDO)
- P.F.L. (PEZZOLI FIAT LANCIA)
- S.I.A.T.A. (SOCIETÀ ITALIANA APPLICAZIONE TRASFORMAZIONI

AUTOMOBILISTICHE)

- SAAB (SVENSKA AEROPLAN AKTIEBOLAGET)
- SAM (SOCIETÀ AUTOMOBILI MOTORI)
- SVA (SOCIETÀ VALDOSTANA)

Attachment 7: Points table for the Time Trial**POINTS TABLE FOR THE TIME TRIAL**

centesimi di secondo		centesimi di secondo		centesimi di secondo		centesimi di secondo	
penalità	punti	penalità	punti	penalità	punti	penalità	punti
0	420	42	158	84	116	126	74
1	395	43	157	85	115	127	73
2	370	44	156	86	114	128	72
3	350	45	155	87	113	129	71
4	330	46	154	88	112	130	70
5	310	47	153	89	111	131	69
6	291	48	152	90	110	132	68
7	272	49	151	91	109	133	67
8	254	50	150	92	108	134	66
9	236	51	149	93	107	135	65
10	226	52	148	94	106	136	64
11	217	53	147	95	105	137	63
12	212	54	146	96	104	138	62
13	207	55	145	97	103	139	61
14	203	56	144	98	102	140	60
15	200	57	143	99	101	141	59
16	198	58	142	100	100	142	58
17	196	59	141	101	99	143	57
18	194	60	140	102	98	144	56
19	192	61	139	103	97	145	55
20	190	62	138	104	96	146	54
21	188	63	137	105	95	147	53
22	186	64	136	106	94	148	52
23	184	65	135	107	93	149	51
24	182	66	134	108	92	150	50
25	180	67	133	109	91	151	49
26	178	68	132	110	90	152	48
27	176	69	131	111	89	153	47
28	174	70	130	112	88	154	46
29	172	71	129	113	87	155	45
30	170	72	128	114	86	156	44
31	169	73	127	115	85	157	43
32	168	74	126	116	84	158	42
33	167	75	125	117	83	159	41
34	166	76	124	118	82	160	40
35	165	77	123	119	81	161	39
36	164	78	122	120	80	162	38
37	163	79	121	121	79	163	37
38	162	80	120	122	78	164	36
39	161	81	119	123	77	165	35
40	160	82	118	124	76	166	34
41	159	83	117	125	75	167	33

POINTS TABLE FOR THE TIME TRIAL

centesimi di secondo		centesimi di secondo		centesimi di secondo		centesimi di secondo	
penalità	punti	penalità	punti	penalità	punti	penalità	punti
168	32	205	0	242	0	279	0
169	31	206	0	243	0	280	0
170	30	207	0	244	0	281	0
171	29	208	0	245	0	282	0
172	28	209	0	246	0	283	0
173	27	210	0	247	0	284	0
174	26	211	0	248	0	285	0
175	25	212	0	249	0	286	0
176	24	213	0	250	0	287	0
177	23	214	0	251	0	288	0
178	22	215	0	252	0	289	0
179	21	216	0	253	0	290	0
180	20	217	0	254	0	291	0
181	19	218	0	255	0	292	0
182	18	219	0	256	0	293	0
183	17	220	0	257	0	294	0
184	16	221	0	258	0	295	0
185	15	222	0	259	0	296	0
186	14	223	0	260	0	297	0
187	13	224	0	261	0	298	0
188	12	225	0	262	0	299	0
189	11	226	0	263	0	300	0
190	10	227	0	264	0		
191	9	228	0	265	0		
192	8	229	0	266	0		
193	7	230	0	267	0		
194	6	231	0	268	0		
195	5	232	0	269	0		
196	4	233	0	270	0		
197	3	234	0	271	0		
198	2	235	0	272	0		
199	1	236	0	273	0		
200	0	237	0	274	0		
201	0	238	0	275	0		
202	0	239	0	276	0		
203	0	240	0	277	0		
204	0	241	0	278	0		

NOTA: il coefficiente assegnato alla vettura deve essere moltiplicato per i punti

Attachment 8: Points table for the Average trial**POINTS TABLE FOR THE AVERAGE TRIAL**

al secondo			al secondo			al secondo			al secondo		
penalità	punti ANTICIPO	punti RITARDO	penalità	punti ANTICIPO	punti RITARDO	penalità	punti ANTICIPO	punti RITARDO	penalità	punti ANTICIPO	punti RITARDO
0	420	420	42	53	158	84	0	116	126	-108	74
1	395	395	43	52	157	85	0	115	127	-111	73
2	370	370	44	51	156	86	0	114	128	-114	72
3	350	350	45	50	155	87	0	113	129	-117	71
4	330	330	46	48	154	88	0	112	130	-120	70
5	310	310	47	46	153	89	0	111	131	-123	69
6	291	291	48	44	152	90	0	110	132	-126	68
7	272	272	49	42	151	91	-3	109	133	-129	67
8	254	254	50	40	150	92	-6	108	134	-132	66
9	236	236	51	38	149	93	-9	107	135	-135	65
10	226	226	52	36	148	94	-12	106	136	-138	64
11	200	217	53	34	147	95	-15	105	137	-141	63
12	185	212	54	32	146	96	-18	104	138	-144	62
13	170	207	55	30	145	97	-21	103	139	-147	61
14	155	203	56	28	144	98	-24	102	140	-150	60
15	140	200	57	26	143	99	-27	101	141	-153	59
16	135	198	58	24	142	100	-30	100	142	-156	58
17	130	196	59	22	141	101	-33	99	143	-159	57
18	125	194	60	20	140	102	-36	98	144	-162	56
19	120	192	61	18	139	103	-39	97	145	-165	55
20	115	190	62	16	138	104	-42	96	146	-168	54
21	110	188	63	14	137	105	-45	95	147	-171	53
22	105	186	64	12	136	106	-48	94	148	-174	52
23	100	184	65	10	135	107	-51	93	149	-177	51
24	95	182	66	8	134	108	-54	92	150	-180	50
25	90	180	67	6	133	109	-57	91	151	-183	49
26	85	178	68	4	132	110	-60	90	152	-186	48
27	80	176	69	2	131	111	-63	89	153	-189	47
28	75	174	70	0	130	112	-66	88	154	-192	46
29	70	172	71	0	129	113	-69	87	155	-195	45
30	65	170	72	0	128	114	-72	86	156	-198	44
31	64	169	73	0	127	115	-75	85	157	-201	43
32	63	168	74	0	126	116	-78	84	158	-204	42
33	62	167	75	0	125	117	-81	83	159	-207	41
34	61	166	76	0	124	118	-84	82	160	-210	40
35	60	165	77	0	123	119	-87	81	161	-213	39
36	59	164	78	0	122	120	-90	80	162	-216	38
37	58	163	79	0	121	121	-93	79	163	-219	37
38	57	162	80	0	120	122	-96	78	164	-222	36
39	56	161	81	0	119	123	-99	77	165	-225	35
40	55	160	82	0	118	124	-102	76	166	-228	34
41	54	159	83	0	117	125	-105	75	167	-231	33

POINTS TABLE FOR THE AVERAGE TRIAL

al secondo			al secondo			al secondo			al secondo		
penalità	punti ANTICIPO	punti RITARDO	penalità	punti ANTICIPO	punti RITARDO	penalità	punti ANTICIPO	punti RITARDO	penalità	punti ANTICIPO	punti RITARDO
168	-234	32	205	-345	0	242	-456	0	279	-567	0
169	-237	31	206	-348	0	243	-459	0	280	-570	0
170	-240	30	207	-351	0	244	-462	0	281	-573	0
171	-243	29	208	-354	0	245	-465	0	282	-576	0
172	-246	28	209	-357	0	246	-468	0	283	-579	0
173	-249	27	210	-360	0	247	-471	0	284	-582	0
174	-252	26	211	-363	0	248	-474	0	285	-585	0
175	-255	25	212	-366	0	249	-477	0	286	-588	0
176	-258	24	213	-369	0	250	-480	0	287	-591	0
177	-261	23	214	-372	0	251	-483	0	288	-594	0
178	-264	22	215	-375	0	252	-486	0	289	-597	0
179	-267	21	216	-378	0	253	-489	0	290	-600	0
180	-270	20	217	-381	0	254	-492	0	291	-603	0
181	-273	19	218	-384	0	255	-495	0	292	-606	0
182	-276	18	219	-387	0	256	-498	0	293	-609	0
183	-279	17	220	-390	0	257	-501	0	294	-612	0
184	-282	16	221	-393	0	258	-504	0	295	-615	0
185	-285	15	222	-396	0	259	-507	0	296	-618	0
186	-288	14	223	-399	0	260	-510	0	297	-621	0
187	-291	13	224	-402	0	261	-513	0	298	-624	0
188	-294	12	225	-405	0	262	-516	0	299	-627	0
189	-297	11	226	-408	0	263	-519	0	300	-630	0
190	-300	10	227	-411	0	264	-522	0	>300	-12000	0
191	-303	9	228	-414	0	265	-525	0			
192	-306	8	229	-417	0	266	-528	0			
193	-309	7	230	-420	0	267	-531	0			
194	-312	6	231	-423	0	268	-534	0			
195	-315	5	232	-426	0	269	-537	0			
196	-318	4	233	-429	0	270	-540	0			
197	-321	3	234	-432	0	271	-543	0			
198	-324	2	235	-435	0	272	-546	0			
199	-327	1	236	-438	0	273	-549	0			
200	-330	0	237	-441	0	274	-552	0			
201	-333	0	238	-444	0	275	-555	0			
202	-336	0	239	-447	0	276	-558	0			
203	-339	0	240	-450	0	277	-561	0			
204	-342	0	241	-453	0	278	-564	0			

NOTA: il coefficiente assegnato alla vettura deve essere moltiplicato per i punti